



Key to symbols



Minimum Height



Maximum Height



Closed Length



Footprint Diameter



Weight



Spigot Size



Socket Size



Grip Head Size



Top Tube Diameter



Suggested Wheels



Maximum Evenly Distributed Load on Level Ground



Patented



German Safety Standard

The products with the TÜV-GS symbol are developed and tested in accordance with DIN 15560 norm.

B **CB** **J**

Ordering

Products may be ordered by using the product code together with its title. Optional Black (B) finish, Black Chrome (CB) finish, and 17mm female attachment (J) versions are available where indicated. Add B, CB, or J to the product code when ordering.

i.e.

A2025F **CB** **J**

Lighting Stand don't fall inside the European directive 98/37/CE and for this reason they don't need "CE" mark



All Avenger products are designed, engineered and made in Italy

 **AVENGER**

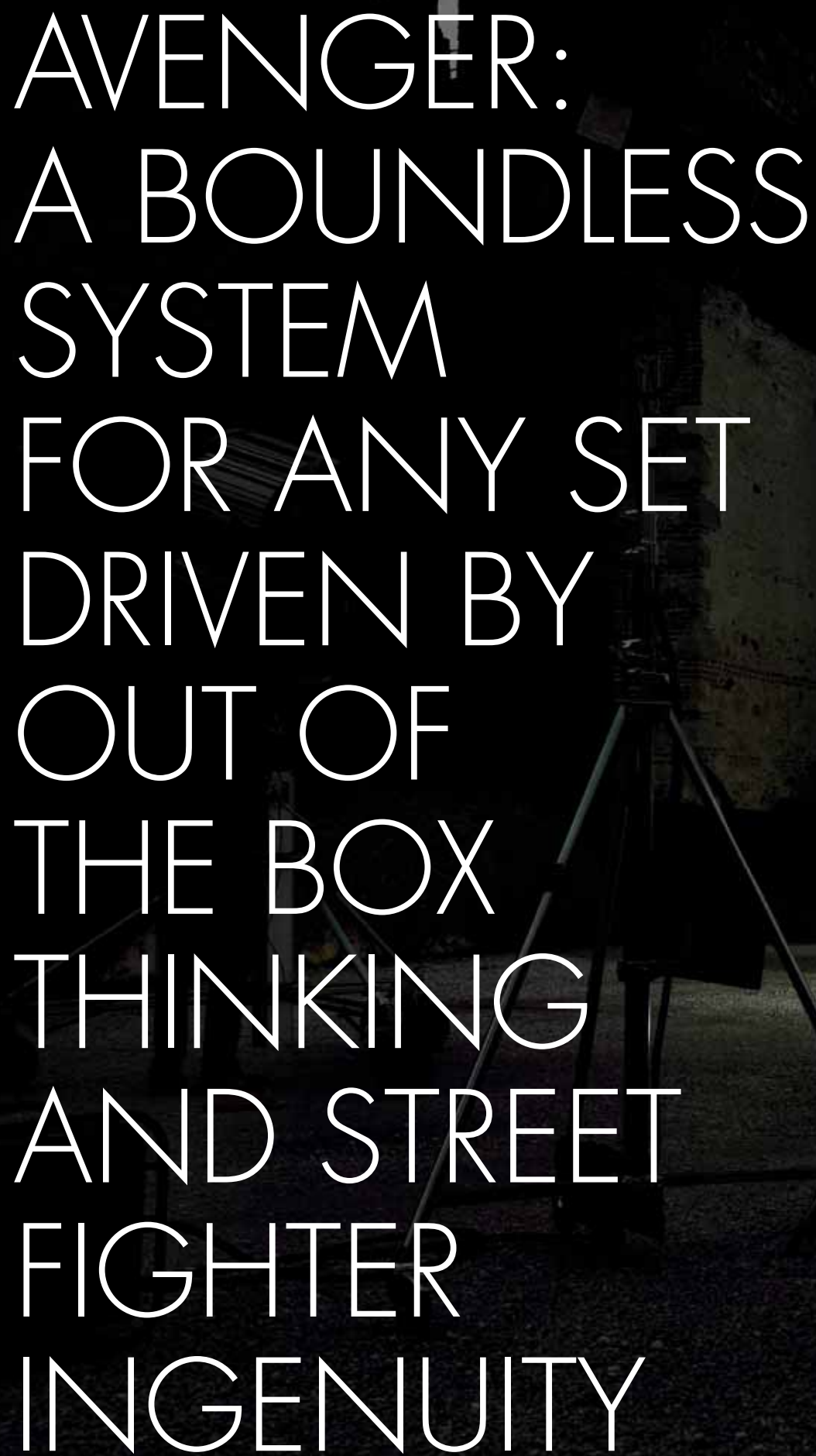

AVENGER:
A BOUNDLESS
SYSTEM
FOR ANY SET
DRIVEN BY
OUT OF
THE BOX
THINKING
AND STREET
FIGHTER
INGENUITY





The AVENGER brand was born 20 years ago, answering to the need of the photo and cine market of having a boundless product for any set. Product quality is the hallmark of this range, which can withstand extreme use, rough atmospheric conditions, very high stress and heavy loads. All products have been designed under the supervision of the most demanding film grippers to match

the strict quality standards and performance needs of the motion picture industry. The result is a complete range of inexhaustible articles that praises some of the most famous products in the cine market: such as the Super Clamp, the Wind Up Stand and the Magic Arm, worldwide famous for their efficiency, ease of use, and reliability. In just one word: all the



Avenger gear truly represents the concept of "problem solver". Today Avenger is part of the Vitec Group, a multi-national company listed in London Stock Exchange that supplies the best products and services for the photo/cine and entertainment area, such as Manfrotto, Gitzo, Vinten and Sachtler. Safety for everyone is a top priority for Avenger. Our world class research

and development team meticulously work to satisfy all the DIN15560 international safety regulations also obtaining certifications such as the TÜV-GS, ISO9001 and ISO14001. Avenger is also proud to be present worldwide with a capillary distribution net, offering a top quality service both before and after sales, supporting the clients from the right choice of the product until providing

every single spare part needed. What better way to celebrate the 20th anniversary, than a brand new catalogue presenting some of the newest products that will be added to the already rich and complete range of Avenger products and a new dedicated website, www.avenger-grip.com, featuring all the product news, and with much information and curiosities on the Avenger world.

PRODUCTS



STANDS

8

LIGHT CONTROL

40

SYSTEMS

50

ACCESSORIES

78



STANDS





The Avenger stand range includes several product families, featuring different designs and materials depending both on the applications they are intended for and on the light type they have to support. These supports have been designed to be both safe and reliable. For that reason, all materials are top quality and are tested in order to withstand extreme uses in all weather conditions.

STANDS PROPERTIES



Aluminum and Steel versions available. Alu Stand for lightness and steel stand for robustness and durability.



Leveling leg available in all the stands for ease of use on all different floor types. A fundamental feature for outdoor applications.



All the components are assembled using bolts (no rivets) for extra rigidity and easy maintenance if required.



Captive handle: thanks to this special machining on the threads, it is impossible to loose the handle even if completely unscrewed.



Captive collars: thanks to a special design, even if the user unscrews the locking nut, of this component the inner alu insert and dedicated machining of the tube does not allow for the column to separate.



Storing Device: this clever component permits easy and safe storage during transportation or in the warehouse.



Mobile Column: thanks to the double handles on the spider casting, the stand becomes more stable when lowering the central column on to the ground.



Dedicated design of the collars. This feature helps to avoid fingers from getting pinched.



All the bases are made of square tubes in order to guarantee the best stability.



All the aluminum columns are assembled using electro-welded tubes. These components offer a higher stress resistance (bending and breaking) compared with the traditional extruded tubes.



All the strategic aluminum components which have to guarantee safety of the product are made using the Gravity Casting technology. This process excludes any possibility of having air bubbles getting into the casting.



Welded spigot (steel version) guarantees the highest mechanical performance and reliability during the products working life.

CODE REFERENCES

A 10 45 CS

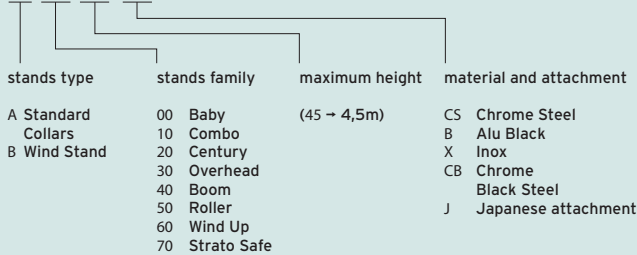

CENTURY STANDS



KIT

A2033FKIT 40" CENTURY STAND KIT

Chrome plated steel stand.
3 sections, 2 risers. Ø: 35, 30, 25mm. Leg Ø: 25mm.

includes:
A2033F C-STAND
D200 2" GRIP HEAD
D520 40" EXTENSION GRIP ARM

A2033LKIT 40" CENTURY STAND KIT W/SLIDING LEG

Chrome plated steel stand.
3 sections, 2 risers. Ø: 35, 30, 25mm. Leg Ø: 25mm.

includes:
A2033L C-STAND
D200 2" GRIP HEAD
D520 40" EXTENSION GRIP ARM

A2030DKIT 40" CENTURY STAND KIT W/DETACHABLE BASE

Chrome plated steel stand.
3 sections, 2 risers. Ø: 35, 30, 25mm. Leg Ø: 25mm.

includes:
A2030D C-STAND
D200 2" GRIP HEAD
D520 40" EXTENSION GRIP ARM

A2018F (REPLACES A255S) | **CB**

20" CENTURY STAND

- 33.1in 68.9in 33.1in 37.4in 9.5lbs
- 17.6lbs 16mm 5/8"

Chrome plated steel stand.
3 sections, 2 risers.
Ø: 35, 30, 25mm. Leg Ø: 25mm.

CB

A2025F (REPLACES A235S) | **CB**

30" CENTURY STAND

- 43.3in 99.6in 43.3in 37.4in 10.6lbs
- 22lbs 16mm 5/8"

Chrome plated steel stand.
3 sections, 2 risers. Ø: 35, 30, 25mm. Leg Ø: 25mm.

CB

A2033F (REPLACES A205S) | **CB**

40" CENTURY STAND

- 52.8in 129.1in 52.8in 37.4in 12.1lbs
- 22lbs 16mm 5/8"

Chrome plated steel stand.
3 sections, 2 risers. Ø: 35, 30, 25mm. Leg Ø: 25mm.

STANDARD BASE

A2018F



A2018L

SLIDING LEG

A2018L (REPLACES A256S) | **CB**

20" SLIDING LEG CENTURY STAND

- 33in 68.9in 33.1in 37.4in 9.5lbs
- 17.6lbs 16mm 5/8"

Chrome plated steel stand.
3 sections, 2 risers. Ø: 35, 30, 25mm. Leg Ø: 25mm.

CB

A2025L (REPLACES A245S) | **CB**

30" SLIDING LEG CENTURY STAND

- 43.3in 99.6in 43.3in 37.4in 12.8lbs
- 22lbs 16mm 5/8"

Chrome plated steel stand.
3 sections, 2 risers. Ø: 35, 30, 25mm. Leg Ø: 25mm.

CB

A2033L (REPLACES A215S) | **CB**

40" SLIDING LEG CENTURY STAND

- 52.8in 129.1in 52.8in 37.4in 12.1lbs
- 22lbs 16mm 5/8"









Chrome plated steel stand.
3 sections, 2 risers. Ø: 35, 30, 25mm. Leg Ø: 25mm.

CENTURY STANDS







DETACHABLE

A2016D (REPLACES A257S) **CB**
20" DETACHABLE CENTURY STAND BASE

-  26.8in
-  54.7in
-  33.1in
-  37.4in
-  4.8lbs
-  22lbs
-  28mm
-  16mm-5/8"
-  28mm-1" 1/8



Chrome plated steel stand.
 3 sections, 2 risers. Ø: 35, 30, 25mm. Leg Ø: 25mm.

A2022D (REPLACES A247S) **CB**
30" DETACHABLE CENTURY STAND BASE

-  43.3in
-  87.4in
-  43.3in
-  37.4in
-  5,9kg
-  22lbs
-  28mm
-  16mm-5/8"
-  28mm-1" 1/8

Chrome plated steel stand.
 3 sections, 2 risers. Ø: 35, 30, 25mm. Leg Ø: 25mm.

A2030D (REPLACES A225S) **CB**
40" DETACHABLE CENTURY STAND BASE

-  52.8in
-  118in
-  52.8in
-  37.4in
-  13.6lbs
-  22lbs
-  28mm
-  16mm-5/8"
-  28mm-1" 1/8

Chrome plated steel stand.
 3 sections, 2 risers. Ø: 35, 30, 25mm. Leg Ø: 25mm.







A2014

COLUMN

A2014 (REPLACES A275S) **CB**



20" DOUBLE RISER COLUMN

 26.8in
  54.7in
  4.8lbs
  16mm-5/8" / 28mm-1" 1/8

3 sections (Ø: 35, 30, 25mm) chrome steel column.

A2020 (REPLACES A272S) **CB**

30" DOUBLE RISER COLUMN

 37.4in
  81.1in
  6.2lbs
  16mm-5/8" / 28mm-1" 1/8

3 sections (Ø: 35, 30, 25mm) chrome steel column.

A2029 (REPLACES A270S) **CB**

40" DOUBLE RISER COLUMN

 46.5in
  112.2in
  7.3lbs
  16mm-5/8" / 28mm-1" 1/8

3 sections (Ø: 35, 30, 25mm) chrome steel column.



A2009

BASE

A2009 (REPLACES A265) **CB**

TURTLE BASE

 10.6in
  37.4in
  6.6lbs
  28mm / 1" 1/8

A2007 (REPLACES A268) **CB**

MINI TURTLE BASE

 10.6in
  29.5in
  6lbs
  28mm / 1" 1/8

CENTURY **STANDS** ACCESSORIES

T-Top
Rubber covering
for added grip of the
handle (different
colours available
for customization).



Dedicated ball bearing.
Fundamental component
for the highest torque.
(+40% jaw's pressure,
+90% twisting
resistance applied to
the arm).



Bearing jacket to
distribute the pressure
generated.



Aluminum handle with
dedicated design for
high locking torque
transmission.



Aluminum jaws.
Four different
gripping diameters
available.



Our Grip Heads have been specifically designed to hold scrims, flags, floppies & cutters mounted on Century Stands, or butterfly frames mounted on Overhead Stands during film, video or photo shoots. Extension offset arms, used in combination with Grip Heads, provide an extended grip point for scrims, flags and small lights, and are available in two lengths: 20" (51cm) and 40" (102cm). The Grip Head can be combined with other accessories to solve most light and light modification accessory positioning problems. Grip Heads are available in two specific diameters, the standard is 2 1/2" the Jumbo version is 4".

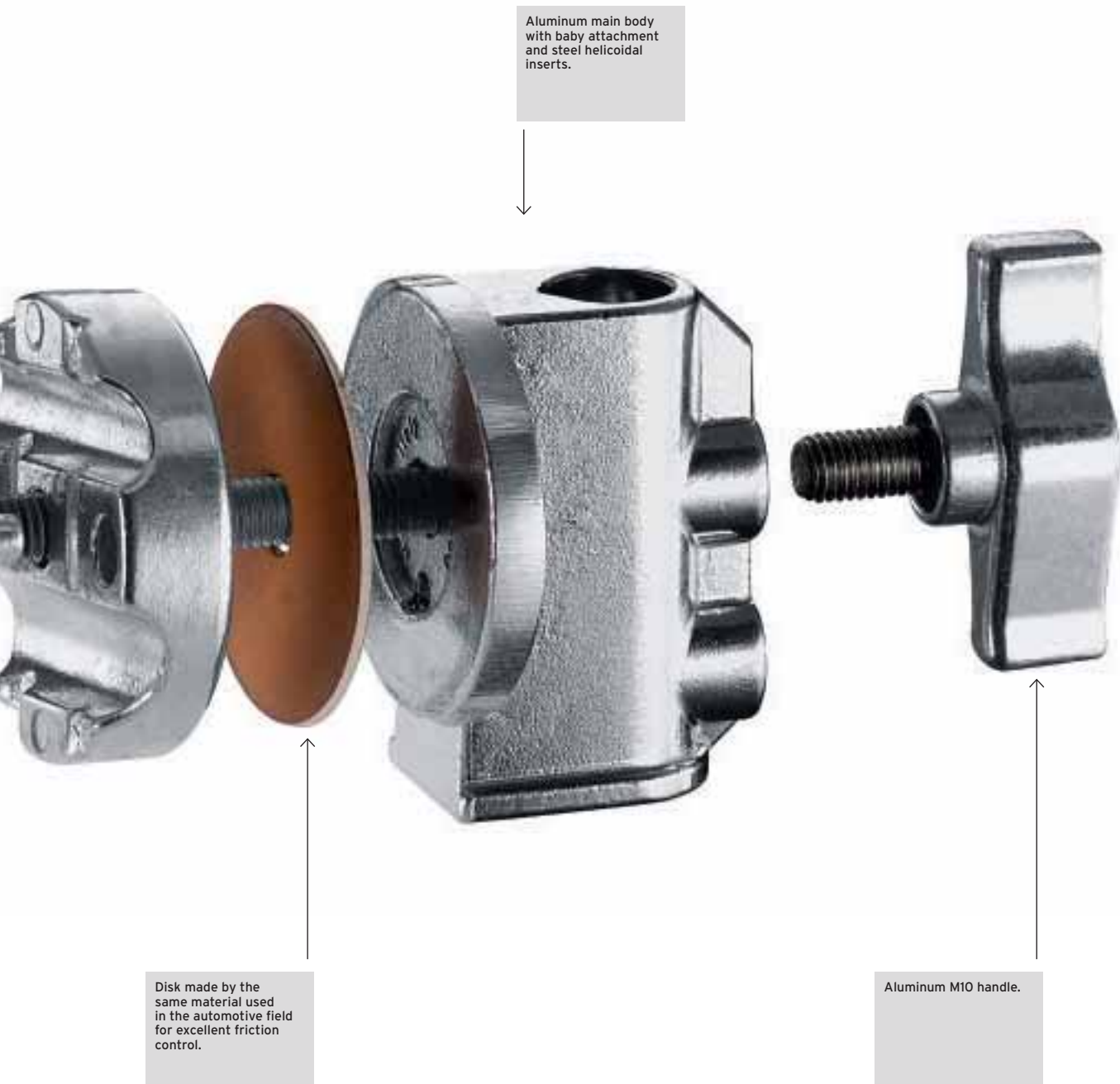

CENTURY **STANDS** ACCESSORIES



D200 **B**
2" 1/2 GRIP HEAD

1.2lbs 16mm
5/8"

Avenger's most popular grip accessory. The D200 Grip Head has hundreds of functions. Unlike any other grip head, the D200 utilizes a series of washers for extra locking torque and the use of automotive-quality brake pad discs for secure, non-slip security.



D210 **B**
SNAP-IN GRIP HEAD

1.4lbs

Combining the multi-functional D200 Grip Head with a hex pin to interface with the original Super Clamp. The D210 allows you to hang flags and scrims in positions that light stands can't reach.



D230 **B**
SUPER CLAMP GRIP HEAD

2.1lbs

Like the D210, this kit includes the D200 Grip Head and the Avenger C1575B Super Clamp.



D220 **B**
GRIP HELPER

2.4lbs 16mm
5/8"

Just as the name suggests, the Grip Helper is like three Grip Heads in one. Two independent grip heads sandwich a third with a fixed 16mm pin. This system allows multiple light control accessories to mount in front of fixtures without the need for numerous light stands.



D250 **B**
GAG GOBO

1lbs

This unique double Grip Head system provides the flexibility of a second grip head allowing hundreds of uses including doubling up scrims and flags.



D240 **B**
GRIP HEAD WITH SWIVEL PIN

2.8lbs

Two famous accessories connected together to assure a wide range of fixing solutions.
Attachments:
16mm male pin + 16mm female socket 28mm male pin.



D100 **B**
DOUBLE GRIP HEAD

1.9lbs

A combination of two sets of Grip Heads discs mounted on a steel plate with a 3/8in rod.
Attachment: 3/8in x 5.3in rod.

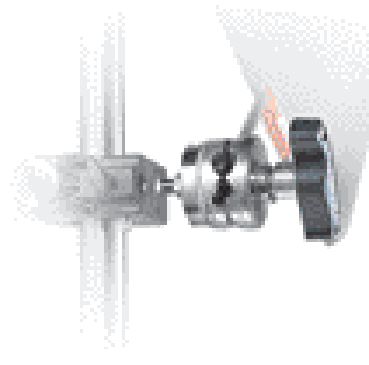

D260 **B**
ADDA HEAD

1.1lbs

Like the D230, but available as a separate unit. The Add ahead provides quick application of a Grip Head into the Super clamp system.

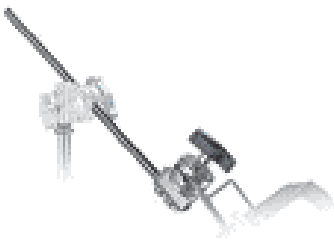

D500 **B**
20" EXTENSION GRIP ARM

3lbs

Normally used in combination with a Grip Head (art. D200) it provides an extended grip point for scrims and flags. Pipe length 20in.

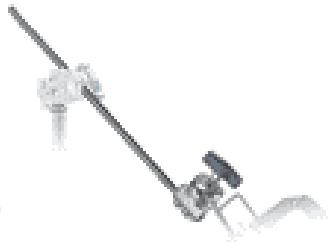

D520 **B**
40" EXTENSION GRIP ARM

3.5lbs

Normally used in combination with a Grip Head (art. D200) it provides an extended grip point for scrims and flags or small lights. Pipe length 40in.



D550 **B**
FUN GRIP ARM

3.4lbs

With its strong joint it solves all positioning problems of scrim, flags or small lights. 42.1in length.



D800KIT
GRIP KIT

Set of accessories that work on their own or in combination with stands to support scrims, flags and lighting fixtures to provide precision and secure control. Kit comprises of:
 D200B Black Grip Head.
 E600 Snap-in 5/8in pin.
 D520B Black 40" extension arm.
 C1575B Black Super Clamp.
 H4BAG Grip Kit bag.



D420 **B**
JUMBO GAG GOBO

2.9lbs

This double 4 1/2" (10mm) Grip Head allows for multiple overheads to be used simultaneously.



D400 **B**
4" 1/2 JUMBO GRIP HEAD

5.2lbs 28mm 1" 1/8 28mm 1" 1/8

Designed to convert a Junior Stand into an Overhead Stand, the D400 incorporates a 4 1/2" (10mm) Grip Head with a Junior Stud and receiver.



E600
SNAP-IN PIN

Specifically designed to connect Grip Head to Super Clamp. Aluminum made.

E600C
SNAP-IN PIN

Same as E600, chromed plated steel made.



D050
SET OF 6 BLUE T-TOPS

Rubber cover gives better grip for 80mm T-handles, even in cold weather. Available also in the following colors:
 Red - code D050R
 Yellow - code D050Y
 Green - code D050G
 Light Blue - code D050LB
 Black - code D050B

BABY STANDS



A0003



A0010

A0003 (PREVIOUS CODE A608B)
BACKLITE BABY STAND

7.9in	38.6in	26in	26.8in
3.1lbs	8.8lbs	16mm 5/8"	

Black steel legs and aluminum riser.
 2 sections, 1 riser.
 Ø: 25, 20mm. Leg Ø: 16mm.

A0010 (PREVIOUS CODE A450)
MIGHTY BABY STAND 10

20.5in	39.4in	18.5in	16.9lbs
5.5lbs	33.1lbs	16mm 5/8"	

Steel legs and aluminum risers, silver only.
 3 sections, 2 risers. Ø: 35, 30, 25 mm.
 Leg: 20x20mm. 1 leveling leg.

A0017 (SIMILAR TO A450)
BABY STAND 17

32.3in	68.9in	28.7in	29.5in
7.7lbs	8.8lbs	16mm 5/8"	

Steel legs and aluminum risers, silver only.
 3 sections, 2 risers. Ø: 35, 30, 25 mm.
 Leg: 20x20mm. 1 leveling leg.

A0025B (SIMILAR TO A625B)

ALU BABY STAND 25

38.6in	98.4in	34.3in	34.3in
6.6lbs	8.8lbs	16mm 5/8"	

Black aluminum stand.
 3 sections, 2 risers. Ø: 35, 30, 25, 20mm
 Leg: 20x20mm. 1 leveling leg.

ALUMINUM

STEEL

STEEL BASE AND ALU COLUMN



A0040B



A0040CS

A0030B (SIMILAR TO A630B)

ALU BABY STAND 30

- 44.5in 118.1in 39.4in 39.4in
- 7.7lbs 22lbs 16mm 5/8"

Black aluminum stand.
4 sections, 3 risers. Ø: 35, 30, 25, 20mm.
Leg: 20x20mm. 1 leveling leg.

A0035B (SIMILAR TO A630B)

ALU BABY STAND 35

- 49.6in 137.8in 44.1in 39.4in
- 7.7lbs 19.8lbs 16mm 5/8"

Black aluminum stand.
4 sections, 3 risers. Ø: 35, 30, 25, 20mm.
Leg: 20x20mm. 1 leveling leg.

A0040B (SIMILAR TO A635B)

ALU BABY STAND 40

- 55.9in 157.5in 48.8in 44.9in
- 8.8lbs 19.8lbs 16mm 5/8"

Black aluminum stand.
4 sections, 3 risers. Ø: 35, 30, 25, 20mm.
Leg: 20x20mm. 1 leveling leg.

A0045B (REPLACES A410B)

ALU BABY STAND 45

- 60.6in 177.2in 53.5in 44.9in
- 8.8lbs 22lbs 16mm 5/8"

Black aluminum stand.
4 sections, 3 risers. Ø: 35, 30, 25mm.
Leg: 20x20mm. 1 leveling leg.

A0030CS

STEEL BABY STAND 30

- 44.5in 118.1in 39.4in 39.4in
- 13.2lbs 22lbs 16mm 5/8"

Chrome plated steel stand.
4 sections, 3 risers. Ø: 35, 30, 25, 20mm.
Leg: 20x20mm. 1 leveling leg.

A0035CS

STEEL BABY STAND 35

- 49.6in 137.8in 44.1in 39.4in
- 15.4lbs 19.8lbs 16mm 5/8"

Chrome plated steel stand.
4 sections, 3 risers. Ø: 35, 30, 25, 20mm.
Leg: 20x20mm. 1 leveling leg.

A0040CS

STEEL BABY STAND 40

- 55.9in 157.5in 48.8in 44.9in
- 16.5lbs 19.8lbs 16mm 5/8"

Chrome plated steel stand.
4 sections, 3 risers. Ø: 35, 30, 25, 20mm.
Leg: 20x20mm. 1 leveling leg.

A0045CS (REPLACES A410C)

STEEL BABY STAND 45

- 60.6in 177.2in 53.5in 44.9in
- 17.6lbs 55.1lbs 16mm 5/8"

Chrome plated steel stand.
4 sections, 3 risers. Ø: 35, 30, 25, 20mm.
Leg: 20x20mm. 1 leveling leg.

COMBO STANDS

A1020B (REPLACES A125B) BLACK LOW ALU COMBO STAND 20

43.3in	78in	36.6in	31.5in	13.2lbs
55.1lbs	28mm 1" 1/8	16mm 5/8"	A9000B (optional)	

Aluminum legs with aluminum risers.
3 sections, 2 risers. Ø: 45, 40, 35mm.
Leg: 25x25mm. 1 leveling leg.

A1035B (REPLACES A115B) ALU COMBO STAND 35

66.1in	137.8in	55.9in	52.8in	15.4lbs
66.1lbs	28mm 1" 1/8	16mm 5/8"	A9000B (optional)	

Aluminum stand.
3 sections, 2 risers. Ø: 45, 40, 35mm.
Leg: 25x25mm. 1 leveling leg.

A1045B (REPLACES A105B) ALU COMBO STAND 45

70.5in	177.2in	61in	52.8in	15.4lbs
66.1lbs	28mm 1" 1/8	16mm 5/8"	A9000B (optional)	

Aluminum stand.
4 sections, 3 risers. Ø: 45, 40, 35, 30mm.
Leg: 25x25mm. 1 leveling leg.

ALUMINUM

A1010CS (REPLACES A128) MINI STEEL COMBO STAND 10

25.2in	39.4in	24.4in	22.4in	9.9lbs
66.1lbs	28mm 1" 1/8	16mm 5/8"	A9000 (optional)	

Chrome steel stand.
2 sections, 1 riser. Ø: 35, 30mm
Leg: 20x20mm. 1 leveling leg.

A1020CS (REPLACES A120) STEEL COMBO STAND 20

43.3in	78in	36.6in	31.5in	17.2lbs
77.2lbs	28mm 1" 1/8	16mm 5/8"	A9000 (optional)	

Chrome steel stand.
3 sections, 2 risers. Ø: 45, 40, 35mm.
Leg: 25x25mm. 1 leveling leg.

A1035CS (REPLACES A110) STEEL COMBO STAND 35

66.1in	137.8in	55.9in	52.8in	26.5lbs
88.2lbs	28mm 1" 1/8	16mm 5/8"	A9000 (optional)	

Chrome steel stand.
3 sections, 2 risers. Ø: 45, 40, 35mm
Leg: 25x25mm. 1 leveling leg.

A1045CS (REPLACES A100) STEEL COMBO STAND 45

70.5in	177.2in	61in	52.8in	28.7lbs
88.2lbs	28mm 1" 1/8	16mm 5/8"	A9000 (optional)	

Chrome steel stand.
4 sections, 3 risers. Ø: 45, 40, 35, 30mm
Leg: 25x25mm. 1 leveling leg.

STEEL

PRODUCTS BELOW ARE AVAILABLE AS OPTIONAL



A9000 BRAKED WHEELS

7.3lbs	198lbs

Ø: 100mm for 20x20 and 25x25mm.
Square legs. Set of three.

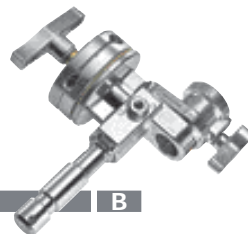

D400 4" 1/2 JUMBO GRIPHEAD

5.2lbs	28mm 1" 1/8	28mm 1" 1/8

Designed to convert a Junior Stand into an Overhead Stand, the D400 incorporates a 4 1/2" (10mm) Grip Head with a Junior Stud and receiver.



A1045B





A1045CS

ROLLER STANDS

A5017 (SIMILAR TO A660)

BABY ROLLER STAND 17 FOLDING BASE

 29.5in
  66.9in
  26in
  29.5in
  13.2lbs

 26.5lbs
  16mm
5/8"

Legs and column in steel, risers in aluminum, complete with wheels. 3 sections, 2 risers. Ø: 35, 30, 25mm. Leg: 20x20mm.





A5017

A5033 (REPLACES A665)

HIGH BABY ROLLER STAND 33 FOLDING BASE

 45.3in
  129.9in
  41.3in
  29.5in
  13.9lbs

 26.5lbs
  16mm
5/8"

Legs and column in steel, risers in aluminum, complete with wheels. 4 sections, 3 risers. Ø: 35, 30, 25, 20mm. Leg: 20x40mm.



FOLDING BASE

LOW BASE

A5029 (REPLACES A420)

BABY ROLLER STAND 29 LOW BASE

 49.2in
  114.2in
  48.4in
  39.4in
  14.1lbs

 26.5lbs
  16mm
5/8"

Legs and column in steel, risers in aluminum, complete with wheels. 3 sections, 2 risers. Ø: 35, 30, 25mm. Leg: 20x20mm.

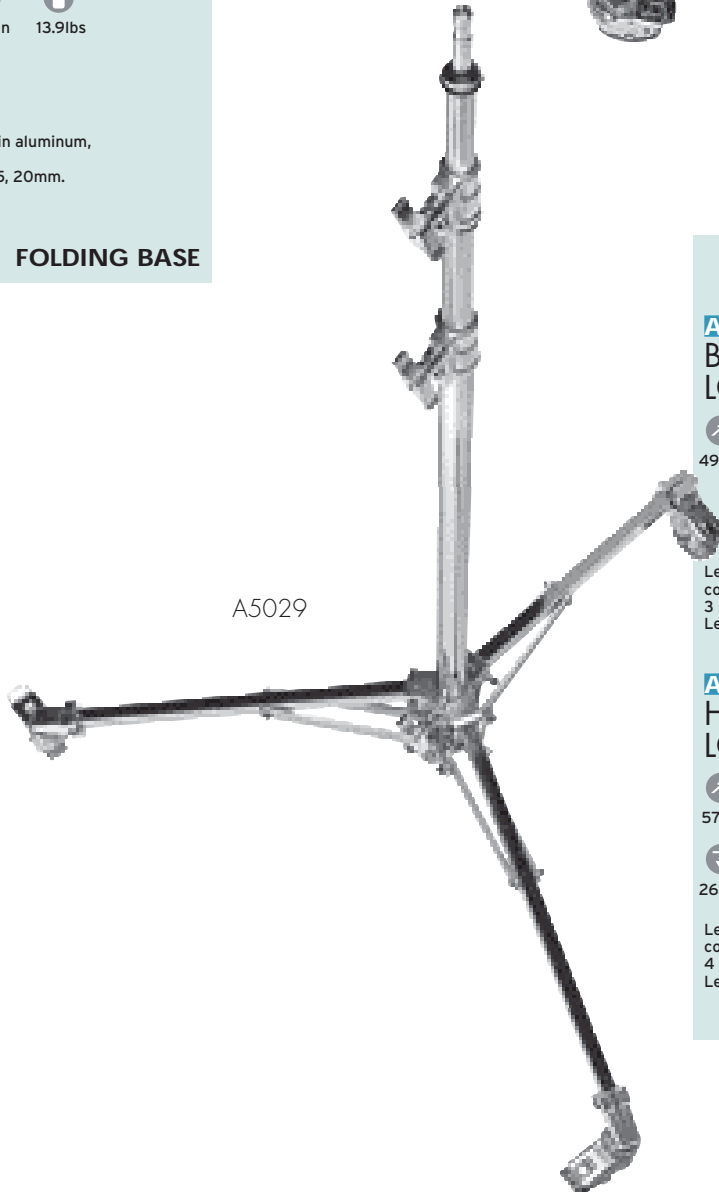



A5029

A5043 (REPLACES A430)

HIGH BABY ROLLER STAND 43 LOW BASE

 57.5in
  169.3in
  53.1in
  41.7in
  15.2lbs

 26.5lbs
  16mm
5/8"

Legs and column in steel, risers in aluminum, complete with wheels. 4 sections, 3 risers. Ø: 35, 30, 25, 20mm. Leg: 20x20mm.

A5012 (REPLACES A680)

LOW BOY JUNIOR ROLLER STAND 12 FOLDING BASE

30.7in 47.2in 26.8in 29.5in 17.6lbs

55.1lbs 28mm 16mm
1" 1/8 5/8"

Legs and column in steel, risers in aluminum, complete with wheels. 3 sections, 2 risers. Ø: 45, 40, 35mm. Leg: 20x40mm.



A5034 (REPLACES A690)

HIGH JUNIOR ROLLER STAND 34 FOLDING BASE

55.9in 133.9in 52in 29.5in 23.6lbs

44.1lbs 28mm 16mm
1" 1/8 5/8"

Legs and column in steel, risers in aluminum, complete with wheels. 4 sections, 3 risers. Ø: 45, 40, 35, 30mm. Leg: 20x40mm.

FOLDING BASE

LOW BASE

A5036CS (REPLACES A510)

JUNIOR ROLLER STAND 36 LOW BASE

61.4in 141.7in 51.2in 55.1in 30lbs

88.2lbs 28mm 16mm
1" 1/8 5/8"

Chrome steel stand, complete with wheels. 3 sections, 2 risers. Ø: 45, 40, 35mm. Leg: 25x25mm.

A5042CS (REPLACES A500)

HIGH JUNIOR ROLLER STAND 42 LOW BASE

65.4in 165.4in 55.9in 59.1in 34lbs

88.2lbs 28mm 16mm
1" 1/8 5/8"

Chrome steel stand, complete with wheels. 4 sections, 3 risers. Ø: 45, 40, 35, 30mm. Leg: 25x25mm.

A5036CS

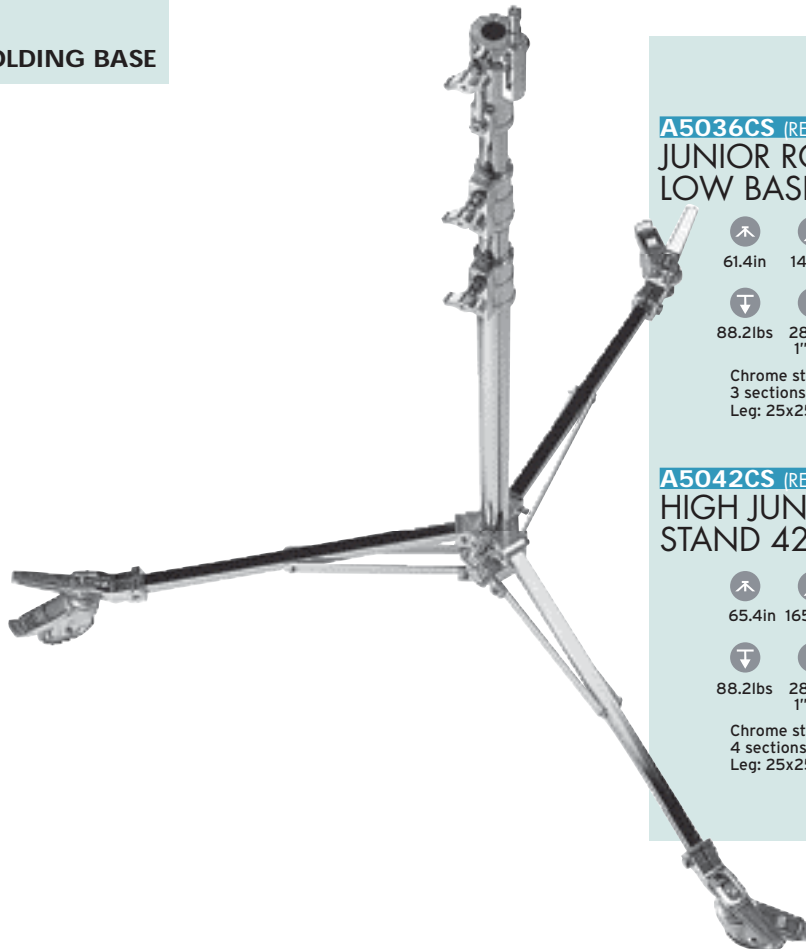

BOOM STANDS



A4039CS (REPLACES A470)

BABY COMBI STEEL BOOM STAND 39

51.6in	154.3in	44.5in	42.9in	18.5lbs
26.4lbs	16mm 5/8"	A9000B (optional)		

Chrome steel stand.
4 sections, 3 risers. Ø: 35, 30, 25, 20mm.
Leg: 20x20mm.
1 leveling leg.

A4041B (REPLACES A475B)









BABY COMBI ALU BOOM STAND 41

54.7in	162.6in	48.8in	50.8in	10.1lbs
22lbs	16mm 5/8"	A9000B (optional)		

Supplied with sandbag counterweight (empty)
for maximum stability and smoothness.
Black aluminum stand. 4 sections, 3 risers.
Ø: 35, 30, 25, 20mm.
Leg: 20x20mm.
1 leveling leg.
Min extension boom 44.5in. Max load 33lbs.
Max extension boom 84in. Max load 11lbs.



A4050CS (REPLACES A700)
JUNIOR STEEL BOOM
STAND 50



-  77in
-  196.9in
-  65in
-  53.1in
-  33lbs
-  66lbs
-  28mm
1" 1/8"
-  16mm
5/8"
-  A9000
(optional)

Chrome steel stand.
 4 sections, 3 risers. Ø: 45, 40, 35, 30mm.
 Leg: 25x25mm.
 1 leveling leg.
 Min extension boom 61in. Max load 66lbs.
 Max extension boom 105in. Max load 17.7lbs.

PRODUCTS BELOW ARE AVAILABLE AS OPTIONAL







E700
BABY DROP
DOWN PIN

-  1.4lbs
-  16mm
5/8"
-  16mm
5/8"

For a more accurate light positioning: it helps keeping the light in horizontal position independently on the angle of the boom. Specifically designed to be used on boom arm with light attachment with 5/8in pin (e.g., D600).



E710
JUNIOR DROP
DOWN PIN

-  2.9lbs
-  28mm
1" 1/8"
-  28mm
1" 1/8"
-  16mm
5/8"

Same as E700, designed to be used on boom arm with light attachment with 1" 1/8 bushing (e.g., D650 or A700).



A9000
BRAKED WHEELS

-  7.3lbs
-  198lbs

Ø: 100mm for 20x20 and 25x25mm.
 Square legs. Set of three.

WIND UP STANDS



B6026CS (REPLACES B205)

IR WIND UP STAND 26 WITH BRAKED WHEELS

60.2in	102.8in	68.1in	59.8in	41.8lbs
99lbs	28mm 1" 1/8"	16mm 5/8"		

Chrome steel stand.
2 sections, 1 riser. Ø: 55, 45mm.
Leg Ø: 30mm.
1 leveling leg.



B6030CS (REPLACES B201)

**WIND UP STAND 30 LOW
BASE WITH BRAKED WHEELS**

- ⚙️ 60.2in
- 📏 116.5in
- 📏 68.9in
- 🕒 55.9in
- 🔒 39.2lbs
- ⬇️ 66lbs
- 📏 28mm
1" 1/8"
- 📏 16mm
5/8"

Chrome steel stand.
3 sections, 2 risers.
Ø: 55, 45, 38mm.
Leg Ø: 30mm.
1 leveling leg.

B6039CS (REPLACES B200)

**WIND UP STAND 39
WITH BRAKED WHEELS**

- ⚙️ 71.3in
- 📏 153.5in
- 📏 79.1in
- 🕒 55.9in
- 🔒 52.8lbs
- ⬇️ 66lbs
- 📏 28mm
1" 1/8"
- 📏 16mm
5/8"

Chrome steel stand.
3 sections, 2 risers.
Ø: 55, 45, 38mm.
Leg Ø: 30mm.
1 leveling leg.

SUPER WIND UP STANDS

B6029X SUPER WIND UP 29 STAND LOW BASE STAINLESS STEEL

55.1in 114.2in 61.4in 51.2in 74.8lbs

176.4lbs 28mm
1" 1/8

Stainless steel column and legs, chrome steel risers and geared column. 4 sections, 3 risers.
Ø: 70, 60, 50mm. Leg: Ø 35mm. 1 leveling leg.

Patented



The codes B6035X, B6040X, B7018, B7059FF are assembled using the new foam fill wheels.

B6040X (SIMILAR TO B250X)
SUPER WIND UP 40 STAND
STAINLESS STEEL
WITH FF WHEELS

- 67.7in
- 152in
- 77.2in
- 70.9in
- 85.8lbs
- 176lbs
- 28mm
- 1" 1/8

Heavy lift stand with strenghtened stainless steel column and legs, chrome steel risers and geared column. 3 sections Ø: 70, 60, 50mm. 2 risers which extended simultaneously at 1.7in per handle turn. Safety cable ensures simultaneous retrieval of all sections. Rapid adjustment. Leg Ø 35mm. 1 leveling leg. Complete with braked wheels.

P
Patented









STRATO SAFE STANDS



B7035CS







B7018 (SIMILAR TO B105N)
STRATO SAFE STAND 18
WITH FF WHEELS

-  41.3in
-  68.9in
-  49.6in
-  47.2in
-  59.5lbs
-  28mm
-  1" 1/8

Aluminum legs with chrome steel column.
 Complete with braked wheels.
 2 sections, 1 riser. Ø: 70, 60mm.
 Leg: 35x35mm.

 Patented

B7035CS (SIMILAR TO B300P)
STRATO SAFE STAND 35
(SAFE CRANK STAND)

-  61in
-  137.8in
-  73.2in
-  71.7in
-  140.8lbs
-  28mm
-  1" 1/8

Chrome steel stand complete with braked wheels.
 3 sections, 2 risers. Ø: 90, 80, 70mm.
 Leg: 35x35mm.

 Patented

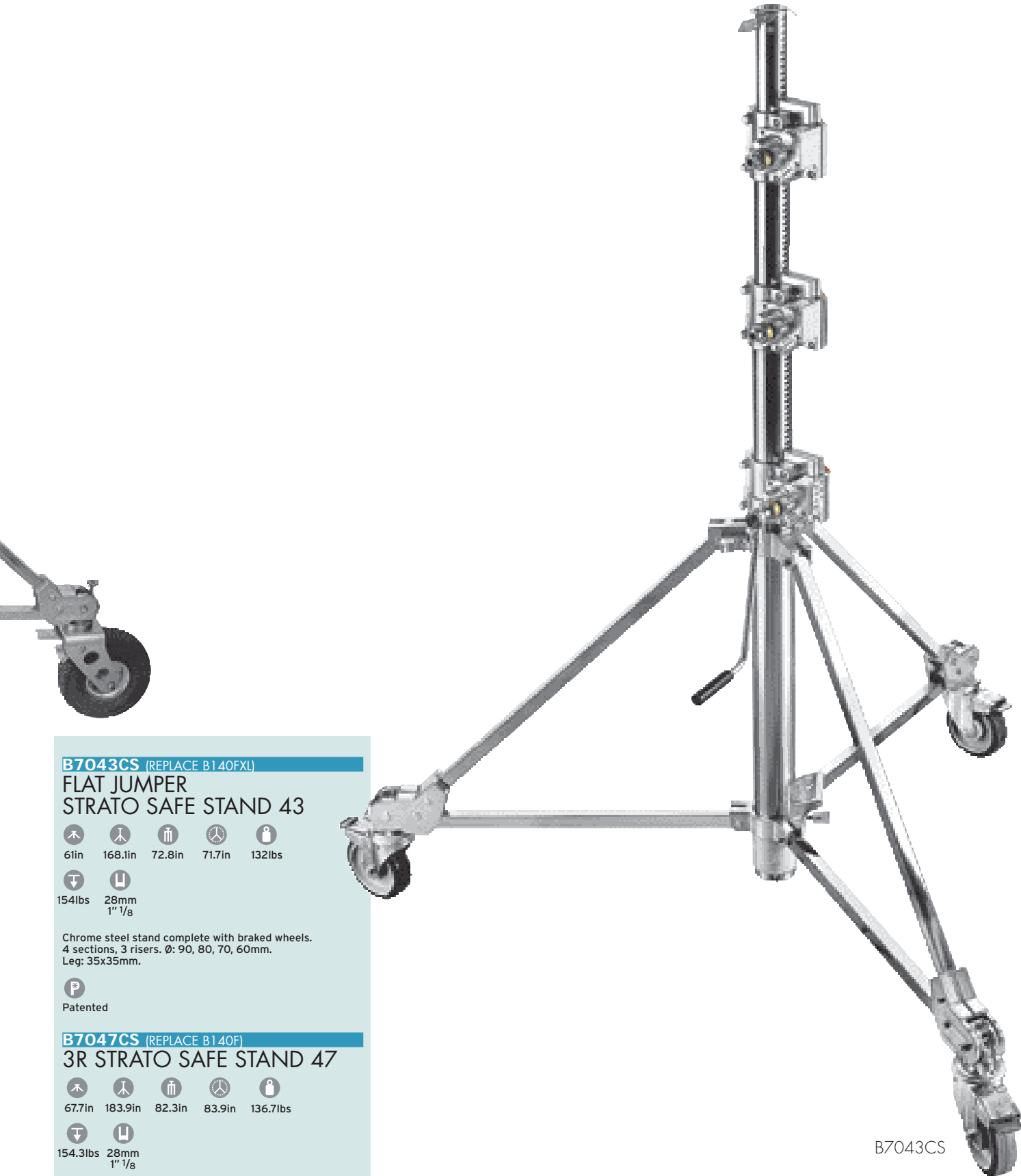

B7043CS (REPLACE B140FXL)

**FLAT JUMPER
STRATO SAFE STAND 43**

- 61in 168.1in 72.8in 71.7in 132lbs
- 154lbs 28mm
1" 1/8

Chrome steel stand complete with braked wheels.
4 sections, 3 risers. Ø: 90, 80, 70, 60mm.
Leg: 35x35mm.

P
Patented

B7047CS (REPLACE B140F)

3R STRATO SAFE STAND 47

- 67.7in 183.9in 82.3in 83.9in 136.7lbs
- 154.3lbs 28mm
1" 1/8

Chrome steel stand complete with braked wheels.
3 sections, 2 risers. Ø: 90, 80, 70mm.
Leg: 35x35mm.
Included Wind Brace Kit B9000W.

P **TUV** **GS**
Patented

B7043CS

LONG JOHN SILVER **STANDS**











B7057
LONG JOHN SILVER STAND

-  70in
-  224.4in
-  88.2in
-  94.5in
-  187.4lbs
-  264lbs
-  28mm
1" 1/8

Heavy duty stand complete with pneumatic braked wheels. 5 sections, 4 risers. Includes Wind Brace Kit B9000W.

 Patented

B7057FF
LONG JOHN SILVER STAND WITH FOAM FILL WHEELS

-  70in
-  224.4in
-  88.2in
-  94.5in
-  187.4lbs
-  264lbs
-  28mm
1" 1/8

Heavy duty stand complete with foam fill braked wheels. 5 sections, 4 risers. Includes Wind Brace Kit B9000W.

 Patented

OVERHEAD STANDS



A3059CS

A3042CS OVERHEAD STAND 42

56.3in	166.5in	53.1in	50.8in	26lbs
88.2lbs	28mm 1" 1/8	45.2in	A9000 (optional)	

Chrome steel stand.
4 sections, 3 risers. Ø: 45, 40, 35, 30mm.
Leg: 25x25mm.

A3059CS OVERHEAD STAND 59

69.7in	231.5in	65.7in	50.8in	30.9lbs
88.2lbs	28mm 1" 1/8	45.2in	A9000 (optional)	

Chrome steel stand.
4 sections, 3 risers. Ø: 45, 40, 35, 30mm.
Leg: 25x25mm.

STANDARD BASE

A3043CS OVERHEAD STAND 43 WITH BRAKED WHEELS

59.8in	170.1in	59.1in	60.6in	35.3lbs
88.2lbs	28mm 1" 1/8	45.2in		

Chrome steel stand complete with braked wheels.
4 sections, 3 risers. Ø: 45, 40, 35, 30mm.
Leg: 25x25mm.

A3058CS OVERHEAD STAND 58 WITH BRAKED WHEELS

73.2in	234.6in	71.7in	60.6in	40.3lbs
88.2lbs	28mm 1" 1/8	45.2in		

Chrome steel stand complete with braked wheels.
4 sections, 3 risers. Ø: 45, 40, 35, 30mm.
Leg: 25x25mm.
Important! Counterweight sandbags must always be used on the legs to ensure safe, stable operation even at full height extension.

ROLLER BASE



A3058CS

A3056CS

WIDE BASE
OVERHEAD STAND 56

78.35in 219.3in 76.8in 77.2in 37lbs

88.2lbs 28mm 45.2in A9000 (optional)
1" 1/8

Chrome steel stand.
4 sections, 3 risers. Ø: 45, 40, 35, 30mm.
Leg: 25x25mm.
1 leveling leg.

A3065CS

WIDE BASE
OVERHEAD STAND 65

79.4in 251.2in 77.6in 80.3in 37lbs

66.1lbs 28mm 45.2in A9000 (optional)
1" 1/8

Chrome steel stand.
5 sections, 4 risers. Ø: 50, 45, 40, 35mm.
Leg: Ø 30mm.
2 leveling leg.



PRODUCT BELOW IS AVAILABLE AS OPTIONAL

D610

C-BOOM/FISHPOLE
HOLDER

1.4lbs

For tubes of max
diameter 1.3in.

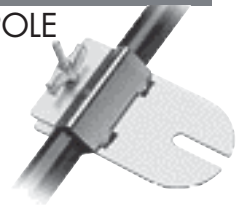



A3065CS

ACCESSORIES **STANDS**





C626
LONG STEEL STAND
EXTENSION

 4.17lbs
  28mm
  16mm
  28mm
 1" 1/8 5/8" 1" 1/8

Chrome length plated steel extension. Length 20.4in.







C624
MEDIUM STEEL STAND
EXTENSION

 3.8lbs
  28mm
  16mm
  28mm
 1" 1/8 5/8" 1" 1/8

Chrome length plated steel extension. Length 15.3in.



C622
SMALL STEEL STAND
EXTENSION

 3.5lbs
  28mm
  16mm
  28mm
 1" 1/8 5/8" 1" 1/8

Chrome length plated steel extension. Length 11in.

C590
CONKA BONKA

Set of 3 Cine extensions.

Long version:
extension 675mm (26,5")
total length 790mm (31,1")
weight 1,75kg (3,86lbs).

Medium version:
extension 270mm (10,6")
total length 385mm (15,6")
weight 1,25kg (2,76lbs).

Short version:
extension 150mm (5,9")
total length 265mm (10,4")
weight 1,09kg (2,4lbs).



C595
BABY BONKA

Set of 3 Cine extensions.

Long version:
extension 675mm (26,5")
total length 721mm (28,3")
weight 0,48kg (1lbs).

Medium version:
extension 270mm (10,6")
total length 316mm (12,4")
weight 0,3kg (0,66lbs).

Short version:
extension 150mm (5,9")
total length 196mm (7,7")
weight 0,25kg (0,55lbs).





027
STAND HOLDER

 6.2lbs

Holder for 8 light stands. Width: 45.2in.
Distance between fixing holes: 25.3in.
Depth: 7.5in.



087WBK
WIND-BRACING KIT

3 rope wind-bracing kit.
Length: 393.7in
Not supplied with the stand.



A9000 **B**
BRAKED WHEELS

 
7.3lbs 98lbs

Ø: 100mm for 20x20 and 25x25mm.
Square legs. Set of three.



G100
SMALL SAND BAG

 13.2lbs

G200
LARGE SAND BAG

 22lbs



AWGS200
CORDURA SAND BAG

 15lbs

AWGS202
CORDURA SAND BAG

 25lbs

LIGHT CONTROL





Avengere offers you anything you need for lighting control on the set: from scrims and flags to dots & fingers, to butterflies. An exceptional offering of 19 different textiles, swiveling kits, and metallic flags. Completing this family a vast range of accessories: from polyholders to traditional frames to fold away frames.

LIGHT CONTROL



D580
UNIVERSAL
ARTICULATED ARM KIT

2.7lbs

Articulated Arm, Mini Clamp, 3/8" Square Adapter, 10mm Socket Adapter, Super Clamp, Hexagonal Adapter, Black Plastic Flag. Arm length: 35.4in.



D390
UNIVERSAL
FLEXTENTION KIT

2.5lbs

Comprising: Flextention Arm, Mini Clamp, 3/8" Square Adapter, 10mm Socket Adapter, Super Clamp, Hexagonal Adapter, Black Plastic Flag. Arm length: 20in.



D340
CAMERA
FLEXTENTION KIT

1.3lbs

Flextention Arm, with 2 Mini Clamps, 3/8" Adapter, 10mm Socket Adapter, Black Plastic Flag.

16in



10in



I800
BLACK METAL FLAG

0.6lbs

Thickness: 0.04in.

13.8in



7.9in

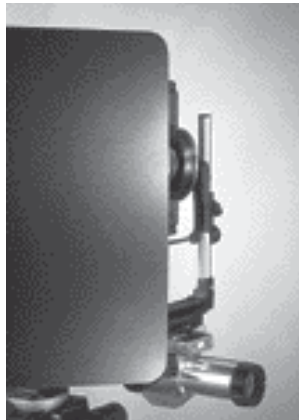

I810
BLACK PLASTIC FLAG

0.3lbs

Thickness: 0.12in.

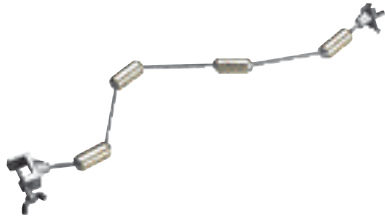

D560
BALL AND SOCKET FLAG ARM

 0.7lbs

Length: 17in.

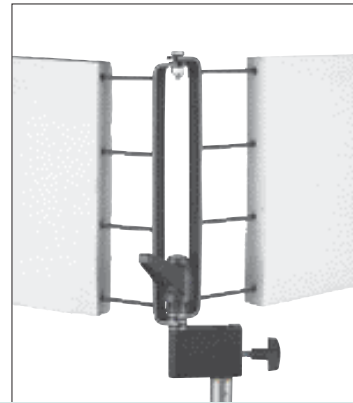

143FV
DOUBLE HINGED FORK

 1.1lbs  16mm
 5/8"

Holds 2 styrene gobos to reflect or cut light on a subject.
 Size 4.9x7.9in.

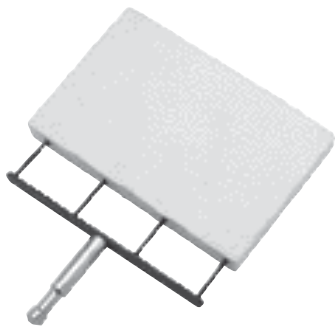

F1504
FOAMCORE FORK 16MM PIN

 0.6lbs  16mm
 5/8"

Similar to the F1501, but includes four pointed pins to mount thicker foam core or gator-board.
 Mounts via a 5/8in pin.



143F
FORK

 0.3lbs

Fork attachment for styrene gobos:
 supplied with 1/4" and 3/8" female attachment.
 Size 4.9x7.9in.



143FD
DOUBLE FIXED FORK

 0.4lbs

Holds 2 styrene gobos to reflect or cut light on a subject.
 Size 4.9x7.9in.

LIGHT CONTROL





F1521 50MM (2") POLYHOLDER WITH 16MM SPIGOT

-  5.5lbs
-  16mm
5/8"

The Polyholder has a 16mm spigot. The "board" clamp has two sides, one white for the reflective side of the polystyrene; one black for the black lightstopping side. It doesn't damage the poly. Plate dimensions: 5.9x8.7in.





F1520 50MM (2") POLYHOLDER WITH SWIVEL JOINT 28MM SPIGOT

-  5.5lbs
-  28mm
1" 1/8"

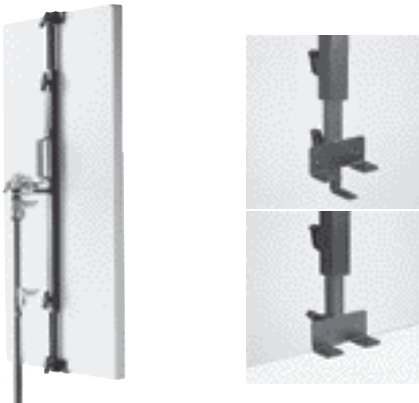
The Polyholder has a 28mm spigot with a ball-and-socket joint to allow rotation and flexible positioning. The board "clamp" has two sides, one white for the reflective side of the polystyrene; one black for the light-stopping side. It doesn't damage the poly. Two metal spikes (on wire retainers) keep the polystyrene board firmly in place. The structure is robustly built to hold thick polystyrene boards, and also has a secondary safety hook to anchor the polyholder to the lightstand/clamp/etc. Plate dimensions: 5.9x8.7in. Mounts via a 1 1/8in pin.



D750 40MM (1.6") TELESCOPIC POLYHOLDER

-  5.5lbs
-  33lbs
-  16mm
5/8"

Max size soldering: 61.4in.
Folded length: 35.8.

Polystyrene is one of the most widely used light bouncers, but it's not the easiest material to handle. Now our Polyholder gives you total control. It grips any thickness, is telescopic to hold most full sheet sizes; then just fixes into the lighting Grip Head D200 mounted on a stand or clamp. What could be easier?

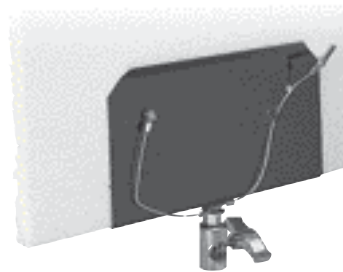

F1501 30MM (1.2") POLYHOLDER

-  1.7lbs
-  16mm
5/8"

A foamcore support clamp to enable precise positioning. Mounts via a 16mm socket.

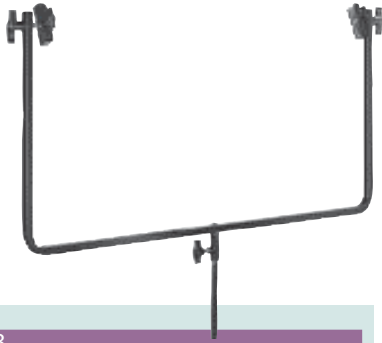

I8030CB

MOUNTING STIRRUP FOR 40" REFLECTOR BOARD

5.5lbs 16mm
5/8"

Will fit reflector board from 0.2 to 1in thickness.
Board not supplied.



D705B

LONG COLLAPSIBLE REFLECTOR HOLDER

1.7lbs 16mm
5/8"

Long Extension Arm.
Max length: 78.2in - Min length: 25.9in



D700B

COLLAPSIBLE REFLECTOR HOLDER

1.5lbs 16mm
5/8"

Extension Arm.
Max length: 48in - Min length: 18.5in

LIGHT CONTROL

FOLD AWAY FRAME

 Patented

Code	Frame Size [feet]	Frame Size [cm]	Tube Thickness [in]	Frame Support	Transport Dimension [in]	Weight [lbs]
H2006	6x6	183x183	1.2x1.2	Ear Type 2	75x5.9x1.2	23.1
H2008	8x8	244x244	1.2x1.2	Ear Type 2	100x5.9x1.2	25.3
H2012	12x12	366x366	1.2x1.2	Ear Type 2	147x5.9x1.2	29.7



FOLD-OUT AND SET UP
Just fix the frame holder
and it is ready to mount!
To order Ear support alone
use code RH02015.

**FOLD-DOWN
AND BRING UP**
Need to move the frame
quickly from set to set?
No problem, just remove
the frame holder, fold down
the frame and carry
the frame with the textile
still fitted!



FOLD AWAY FRAME COMPACT

Patented



Code	Frame Size [feet]	Frame Size [cm]	Tube Thickness [in]	Frame Support	Transport Dimension [in]	Weight [lbs]
H2508	8x8	244x244	1.2x1.2	Ear Type 2	51x6.5x3.3	32.6
H2512	12x12	366x366	1.2x1.2	Ear Type 2	75x6.5x3.3	37.5



FOLD-DOWN AND BRING UP
 Fold Away Compact is the evolution of the standard version. A locking mechanism allows the frame to be folded even smaller for even easier transportation.

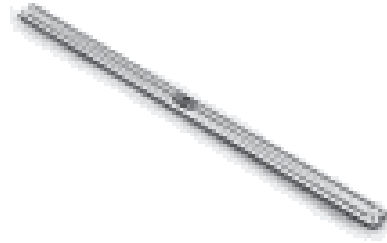

11550KIT

DOT & FINGER KIT

Comprising:

- 1 x 3" (7.5cm) Single+Double
- 1 x 6" (15cm) Single+Double
- 1 x 6" (15cm) Silk
- 2 x 6" (15cm) Flags
- 1 x 12" (30cm) Single
- 1 x 14" (36cm) Silk
- 1 x 14" (36cm) Flag
- 2 x Mini Flex Arm, 1 Bag

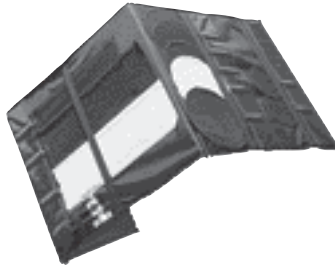

LIGHT CONTROL

LIGHTWEIGHT FRAMES

The Manfrotto Deluxe Fast-Loc Frame kit is lightweight and quick to set up. The square section aluminum tubes slide and lock together to provide a strong frame which supports lighting control textiles of (4'x4' and 6'x6' in size).

Code	Frame Size [feet]	Frame Size [cm]	N. of tubes per side	Tube Length x Thickness [in]	Tube Connection	Frame Support	Weight [lbs]	Optional Frame Bag
H440	4x4	122x122	1	640x1.4	insert	Stud Type x1	1.3	H6BAG
H660	6x6	183x183	1	1205x1.4	insert	Stud Type x2	15.2	H6BAG

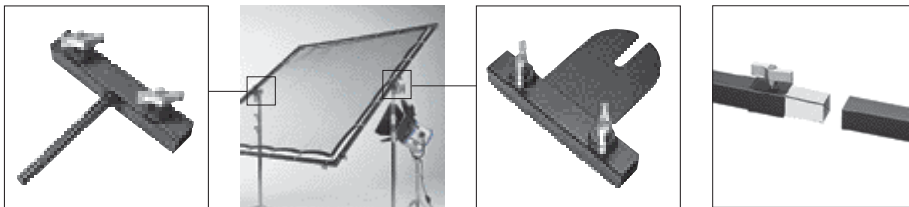
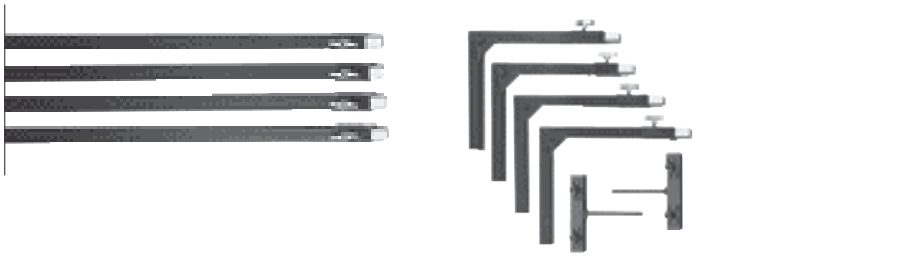

Stud Type (code RH01051)

The Manfrotto Butterfly Frames uses two methods of support. Ear and Stud as illustrated.

Ear Type (code RH01016)

Insert tube connection

MODULAR FRAMES

Heavy duty 3mm square section tubes-slot and pin-lock together, rapidly providing a stable frame for lighting control textiles. By reducing or adding tubes you can create any frame size.

Code	Modular Frame Size [feet]	Modular Frame Size [cm]	N. of tubes per side	Tube Length x Thickness [in]	Tube Connection	Frame Support	Weight [lbs]	Optional Frame Bag
H400M	4x4	122x122	1	1205 x 3	N/A	Ear Type x 1	16	H6BAG
H600M	6x6	183x183	1	1205 x 3	Pin	Ear Type x 2	25.1	H6BAG
H800M	8x8	244x244	2	610 x 3	Pin	Ear Type x 2	30	H6BAG
H1200M	12x12	366x366	3	1205 x 3	Pin	Ear Type x 2	41.9	H6BAG
H2000M	20x20	610x610	5	1205 x 3	Pin	Ear Type x 2	71.9	H6BAG



MODULAR FRAME CONVERSION KITS

Code	Conversion kit [feet]	Conversion kit [cm]
H406EXT	from 4x4 to 6x6	12 x122 to 183x183
H408EXT	from 4x4 to 8x8	122x122 to 244x244
H806EXT	from 20x20, 12x12 and 8x8 to 6x6	610x610, 366x366 and 244x244 to 183x183
H812EXT	from 8x8 to 12x12	244x244 to 366x366
H1220EXT	from 12x12 to 20x20	366x366 to 610x610

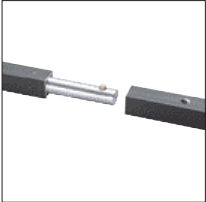

Pin tube connection.

D.I.Y. BUTTERFLY PIPE CORNER KITS

Pipe specifications for use with the D.I.Y Butterfly Pipe Corner Kits.

Code	Nominal Bore [inches]	Outside Diameter [inches]	Nominal Bore [mm]	Outside Diameter [mm]
H9000	1 1/2"	1 29/32"	38	48.3
H9500	1 1/4"	1 11/16"	32	42.4

These two different kits, which contain corners and supports, give you the possibility of making frames of any dimension, using standard aluminum pipes. See the above chart for the right diameter of pipes to use.



Pipe connection.



SYSTEMS

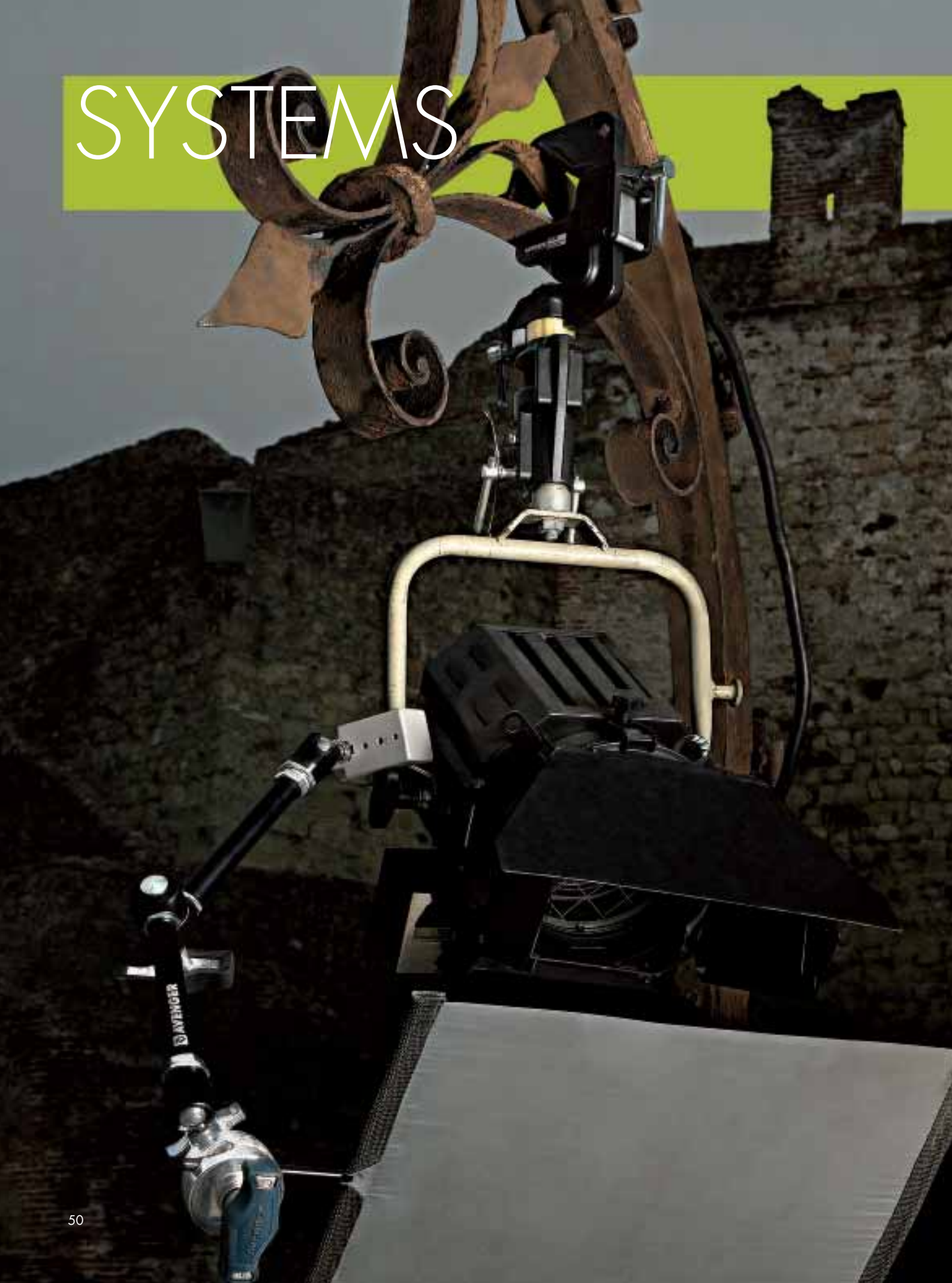

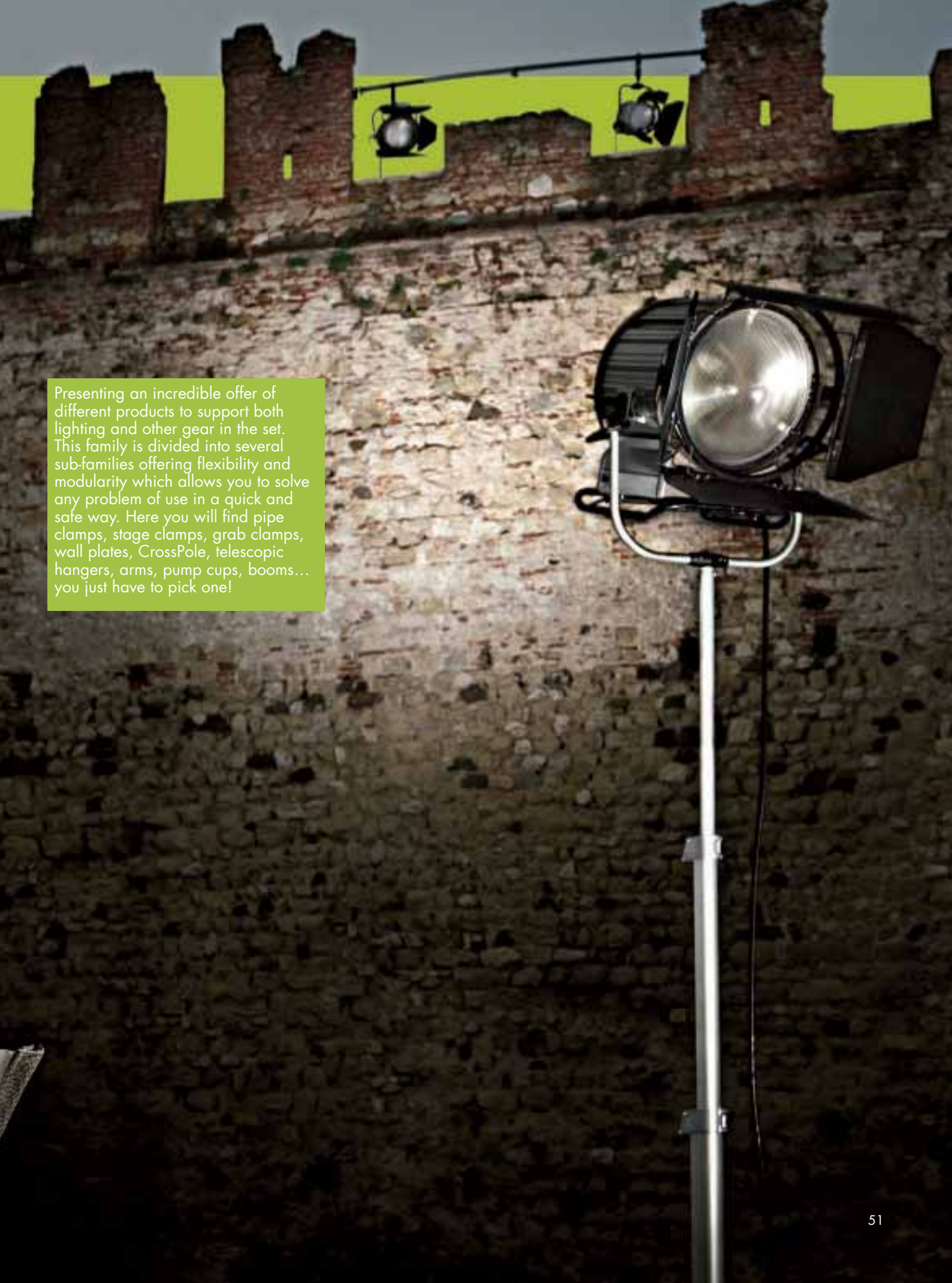

Presenting an incredible offer of different products to support both lighting and other gear in the set. This family is divided into several sub-families offering flexibility and modularity which allows you to solve any problem of use in a quick and safe way. Here you will find pipe clamps, stage clamps, grab clamps, wall plates, CrossPole, telescopic hangers, arms, pump cups, booms... you just have to pick one!

SYSTEM PROPERTIES



Gravity Casting: All the strategic aluminum components which have to guarantee safety of the product are made using the Gravity Casting technology. This process excludes any possibility of having air bubbles getting into the casting.



Quick Action Device: This mechanical concept allows an incredible speed in locking and unlocking the clamp's jaws. The Quick Action line of clamps consists of four models that in dimension, load capacity (up to 220lbs) and coupling range (up to 1.97in).

1322lbs				C345 C345K C345BK ø 1.65"-2.1"	
1102lbs	C4460 ø 1.65"-2.1"	C4469 ø 1.65"-2.1"			
661lbs	C4560 ø 1.65"-2.1"			C4465 ø 1.65"-2.1"	
551lbs				C100 ø 0.79"-2.2"	
330lbs	C339 ø 1.6"-2.6"				
220lbs		C345 C345K C345BK ø 1.65"-2.1"		C337 ø 1.6"-2.8"	
165,3lbs		C150 ø 1.1"-3.1"		C339UH ø 1.6"-2.6"	
110lbs	C280 ø 1.2"-2.1"	C339BB ø 1.6"-2.6"	C150 ø 1.1"-3.1"	C295 ø 1.2"-2.1"	
33lbs		C1575 ø 0.5"-2.2"	C1550 ø 0.5"-2.2"		
22lbs			C500 ø 0.6"-3.1"		

max load

spigot/socket type





FEM Analysis: All the structural components that are crucial for the safety or have to support high stress are engineered using the FEM analysis. The FEM (Finite Element Method) permits simulation of external forces in different applications and to calculate the resulting stress on the component. Using this tool Avenger can optimize the design of the product obtaining the highest performance combined with the lowest weight.



Multifix: The Multifix feature of the "System" product family offers an incredible range of different attachments. Thank to the multifix system the user can hang the product in a various ways. The clamps are manufacturer with multi attachment points or a single attachment points available with a variety of different fixing accessories.

					1322lbs
C4464 ø 1.7"-2.1"	C4462 ø 1.7"-2.1"	C4461 ø 1.7"-2.1"			1102lbs
C4564 ø 1.9"-2.1"		C4470 ø 1.7"-2.1"		C4463 ø 1.9"-2.1"	661lbs
					551lbs
		C339JS ø 1.6"-2.6"	C339SP ø 1.6"-2.6"	C339LE ø 1.6"-2.6"	330lbs
C151 ø 28-78mm	C345-C345K C345BK ø 1.7"-2.1"	C210 ø 0.4"-2.2"			220lbs
	C339UH ø 1.6"-2.6"				165,3lbs
	C338 ø 0.8"-2.1"	C285 ø 1.2"-2.1"	C290 ø 1.2"-2.1"		110lbs
					33lbs
	C150 ø 1.1"-3.1"	C500 ø 0.6"-3.2"			22lbs
M12	male 16mm - 5/8"	male 28mm - 1" 1/8	pulley	ring	

CLAMP SYSTEM

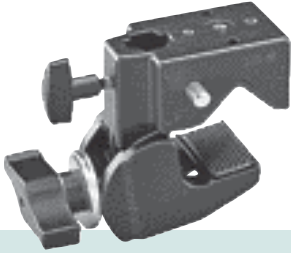

C1575B
SUPER CLAMP

- 1lbs
- 33lbs
- 16mm
5/8"

Ideal clamp for Cine, Broadcast or Lighting & Entertainment applications. Clamping system achieved via a metal knob ensuring extra solidity. Works on diameters from 0.51in to 2.16in.

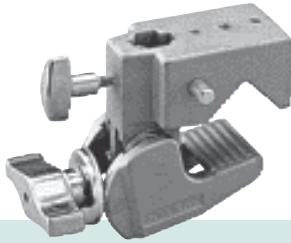

C1550
HEAVY DUTY
SUPER CLAMP

- 1lbs
- 33lbs
- 16mm
5/8"
-

Extra strong version of Super Clamp because of a special manufacturing process named gravity casting, allowing heavier manipulation. Works on diameters from 0.51in to 2.16in.

PRODUCT BELOW IS AVAILABLE AS OPTIONAL

E600
E600C
SUPER CLAMP
ADAPTERS

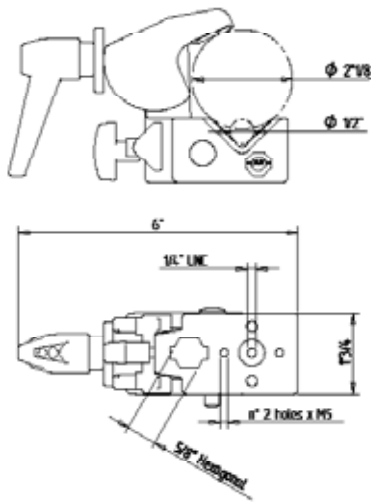
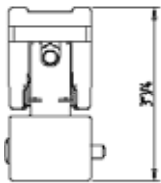

C155
SAFETY CABLE

Diameter 0.16in. Length 39.3in.

C155-02
SAFETY CABLE

Diameter 1.9in. Length 27.5in.



C155-01
SAFETY CABLE

Diameter 1.37mm. Length 27.5in.

C155-03
SAFETY CABLE

Diameter 2.3in. 39.3in.

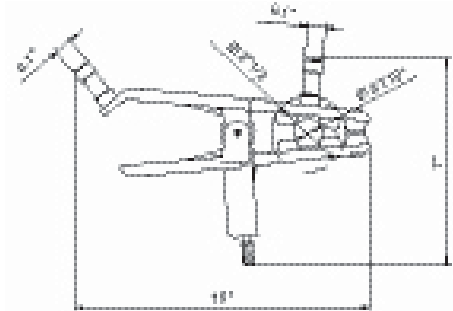
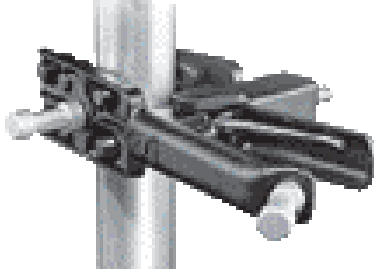

C1525
SKY HOOK

-  1.8lbs
-  6.1"
-  6.1"

Gaffer grip with adjustable jaws.
Grip from: 1in to 2.5in.



C500
PELICAN
GAFFER GRIP

-  3.1lbs
-  22lbs
-  17mm
-  16mm
-  5/8"

Works on diameters 0.6in to 3.1in.

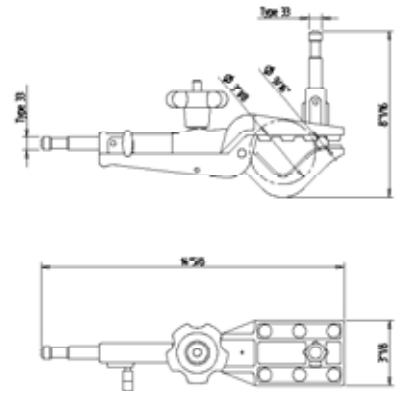

CLAMP SYSTEM

C100 JUNIOR PIPE CLAMP WITH 1" 1/8 SOCKET

- 
2.5lbs
- 
550lbs
- 
28mm
1" 1/8
- 

Works on diameters from 0.78in to 2.1in.

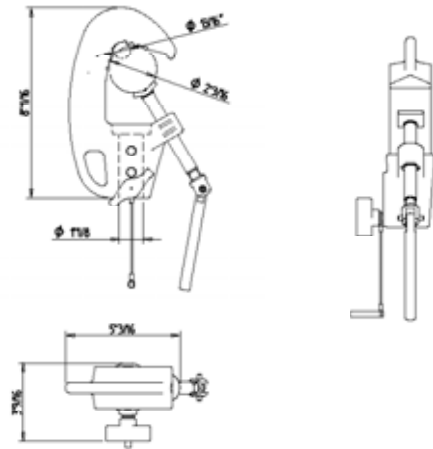

C210 BABY PIPE CLAMP WITH 5/8" STUD

- 
1.4lbs
- 
220lbs
- 
16mm
5/8"
- 

Works on diameters from 0.39in to 2.1in.

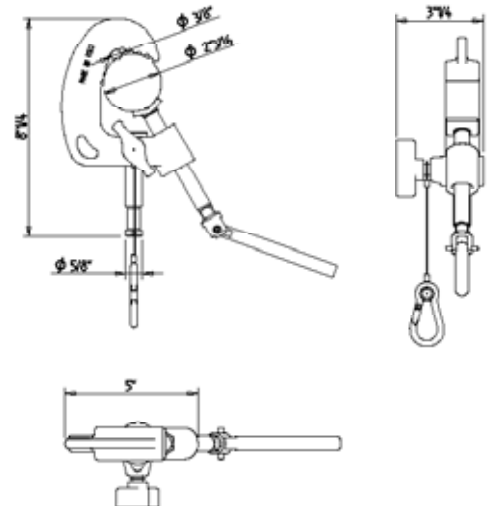
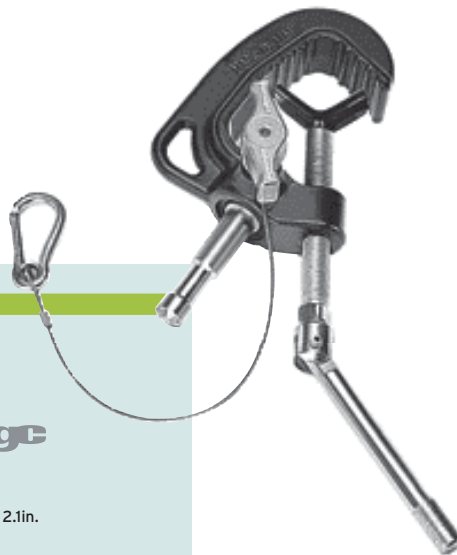

C150
SWIVELING
"C" CLAMP

-  3.5lbs
-  22/165lbs*
-  28mm
1" 1/8
-  16mm
5/8"
- 

Works on diameters from 1.1in to 3in.

* 22lbs on 5/8in attachment,
 165lbs on 1 1/8in attachment.

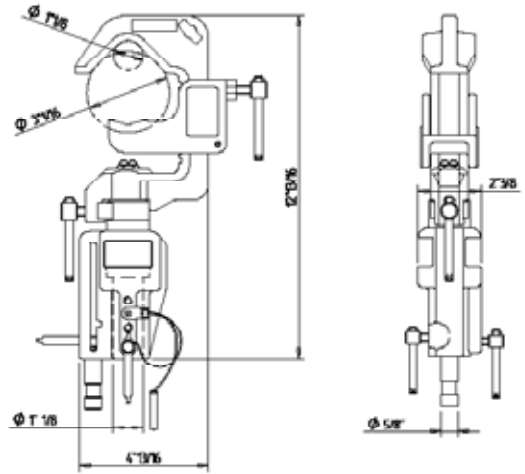
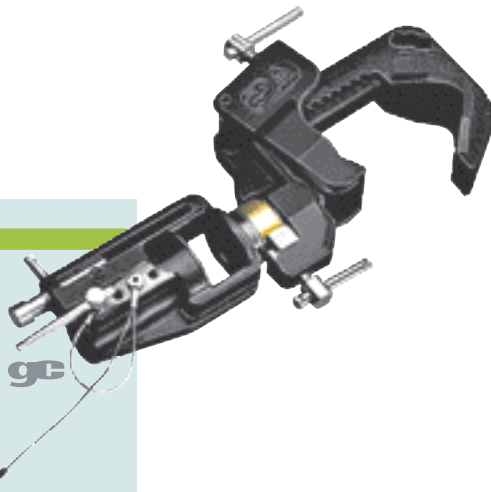

C151
SWIVELING "C" CLAMP
WITH M12 SCREW

-  2.4lbs
-  220lbs
-  M12
- 

Works on diameters from 1.1in to 3.1in.

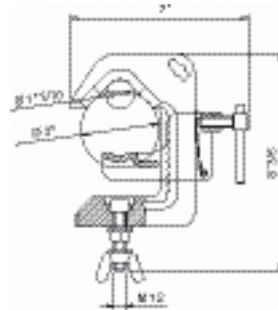

CLAMP SYSTEM



C337 QUICK ACTION JUNIOR CLAMP 1" 1/8 BUSHING

-  2.8lbs
-  220lbs
-  28mm
1" 1/8"

Made in gravity cast aluminum, this clamp is ideal to hang all types of luminaires in TV studios and theaters. Its incredible "coupling range" sets almost no limitations to its capability to clamp to almost all the industry standard pipe diameters. To meet all safety requirements, we have designed a dedicated slot for flexible steel safety cables. Supplied with T-top padded handle to improve grip. Pipe size 1.56in - 2.75in.

 Pat pending 

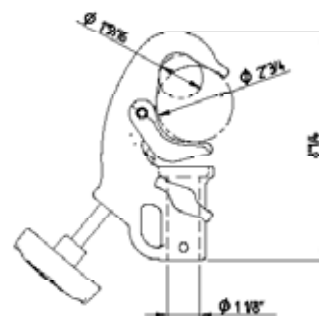

C338 QUICK ACTION BABY CLAMP 5/8" PIN

-  1.7lbs
-  110lbs
-  16mm
5/8"

Very slim and lightweight, this version has been designed for small luminaires, virtually unlimited in application. To meet all safety requirements, we have designed a dedicated slot for flexible steel safety cables. Pipe size 0.75in - 2.04in.

 Pat pending

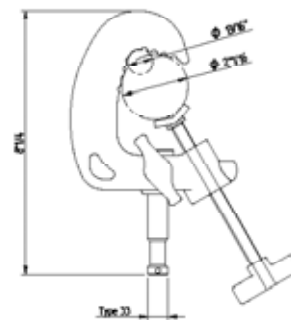

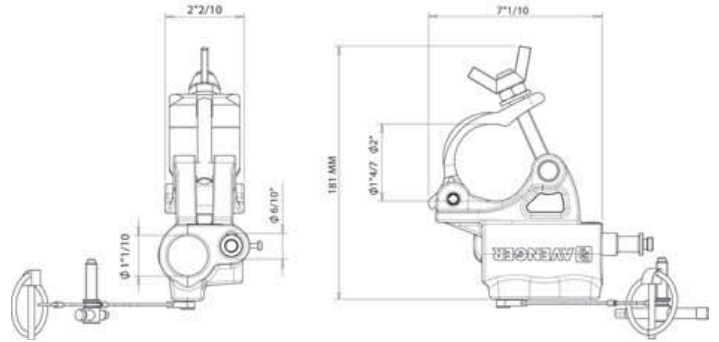

C345
BARREL CLAMP

- 2.1lbs
- 220/1322lbs*
- 28mm
1" 1/8
- 16mm
5/8"
-

Works on diameters from 16.8lbs to 20.5lbs.

* 220lbs on 5/8" attachment,
1322lbs on 1 1/8" attachment.

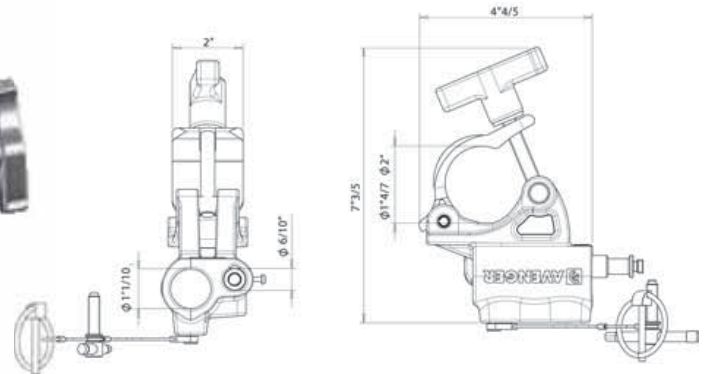
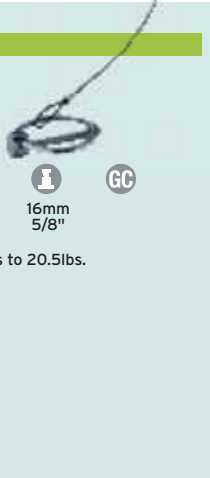

C345K
BARREL CLAMP

- 2.1lbs
- 220/1322lbs*
- 28mm
1" 1/8
- 16mm
5/8"
-

Works on diameters
from 16.8lbs to 20.5lbs.

* 220lbs on 5/8" attachment,
1322lbs on 1 1/8" attachment.



CLAMP SYSTEM



C280
STAGE CLAMP

- 
0.8lbs
- 
110lbs
- 
0.51in hole



C285
STAGE CLAMP WITH
5/8" STUD

- 
1lbs
- 
110lbs
- 
16mm
5/8"

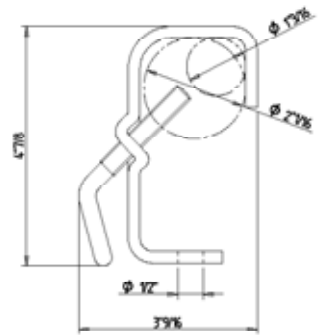

Work on diameters from 1.18in to 2in.
The double locking knob position always provides an optimal grip point.



C290
STAGE CLAMP WITH
1" 1/8 STUD

- 
2lbs
- 
110lbs
- 
16mm
5/8"



C295
STAGE CLAMP WITH
1" 1/8 SOCKET

- 
1.7lbs
- 
110lbs
- 
28mm
1" 1/8

The Grab Clamp is flexible and fast to use thanks to its pincer jaw design and rapid locking and release mechanism. It can be fixed to a wider range of supports than traditional clamps and is suitable for use in TV, video and photographic studios, theatres and rigging structures. The Grab Clamp will hold all kinds of lights, scenery, monitors and much more besides. The Grab Clamp has been designed to be mounted on a wide range of beams, pipes and bars, whether round, square or rectangular in section. It needs no adapter - just open and clamp it.

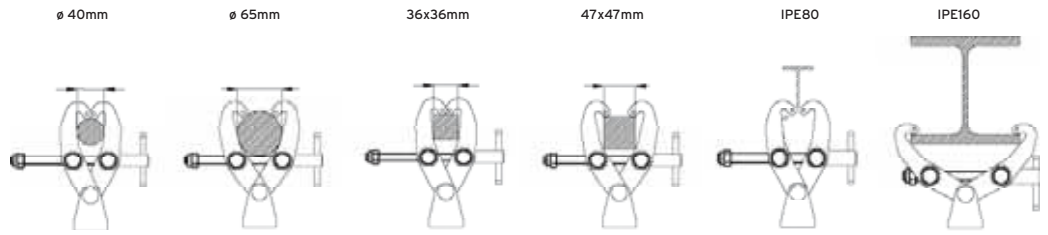

Clamp Range: 1.6in to 2.6in

Clamp Range: 1.4in to 1.9in

Clamp Range: IPE 80 to IPE 160
HEB 80 to HEB 160

IPE and HEB is Standard Building Code for beams.



C339
GRAB CLAMP

- 2.6lbs
- 330lbs
- 0.49" hole

Supplied without attachment, but with a 0.49" hole for custom fixings.



C339JS
GRAB CLAMP WITH 1" 1/8 TV SPIGOT

- 3.1lbs
- 330lbs
- 28mm 1" 1/8

Supplied with 1" 1/8 spigot.



C339BB
GRAB CLAMP WITH 5/8" BUSHING

- 3lbs
- 110lbs
- 16mm 5/8"

Comes with 5/8" bushing complete with push button for extra-safe attachment.



C339LE
GRAB CLAMP WITH LIFTING EYE

- 3.1lbs
- 330lbs
- Ring

Complete with standard lifting eye for chain or rope fixture.

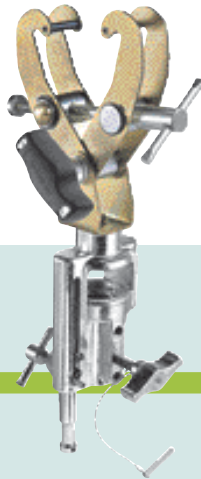

C339UH
DOUBLE GRIP HEAD

- 4.3lbs
- 165lbs
- 28mm 1" 1/8
- 16mm 5/8"

Provided with a universal fixed (non-rotating) head.



C339SP
GRAB CLAMP WITH SPINNING PULLEY

- 3.6lbs
- 330lbs
- Pulley

Fitted with a 3.9in diameter pulley to offer a quick and robust hanging point for TV and theatre sceneries.

MP EYE COUPLER SYSTEM

MP EYE COUPLERS: wider clamp range from 1 1/4in to 2in and special flattened shape of lower jaw.

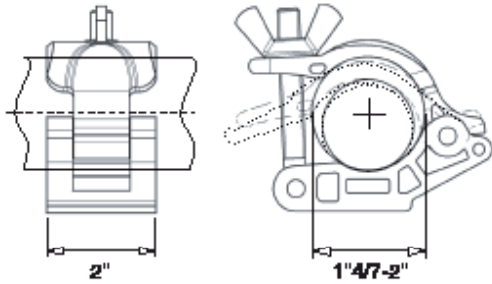

C4460

MP EYE COUPLER



0.9lbs 1100lbs 13mm hole

The base model of MP Eye Coupler for any customized application.



C4461

MP EYE COUPLER WITH 1" 1/8 TV SPIGOT



1.3lbs 1100lbs 28mm 1" 1/8

Supplied with 1 1/8" spigot for TV/broadcast luminaires.



C4462

MP EYE COUPLER WITH 5/8" SPIGOT



1lbs 1100lbs 16mm 5/8"

Designed with 5/8" spigot suitable for lightweight luminaires.





C4463

**MP EYE COUPLER
WITH LIFTING RING**

-  1.3lbs
-  660lbs
-  Ring

Provided with lifting ring for multipurpose use with chains, wires and ropes.

C4464

**MP EYE COUPLER
WITH M12 BOLT PLUS NUT**

-  0.9lbs
-  1100lbs
-  M12x27

Twin couplers fixed parallel for firm, quick and easy interconnection for truss, bars or pipes.

C4465

**MP EYE COUPLER
WITH 1" 1/8 BUSHING**

-  1.9lbs
-  660lbs
-  28mm
1" 1/8

Designed with 1" 1/8 bushing suitable for 2K+ stirrup luminaires.

MP EYE COUPLER SYSTEM



C4469
MP EYE COUPLER
WITH 5/8" BUSHING

 0.9lbs
  1100lbs
  16mm
 5/8"

Supplied with 5/8" spigot for light fixing accessories.





C4470
TILT & SWIVEL
MP EYE COUPLER

 2.9lbs
  660lbs
  28mm
 1" 1/8

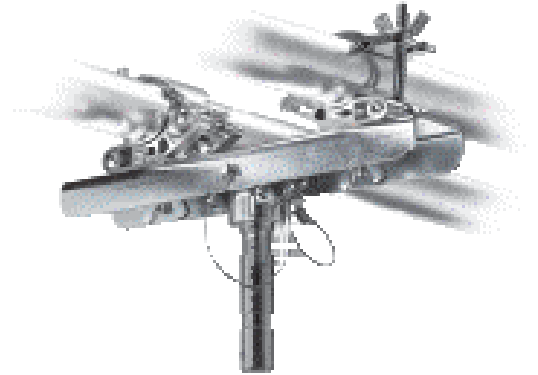
Provided with 1 1/8" spigot to enable to rig a bar or a frame structure between two stands with 360° spigot rotation and swivel system.



C4485
SWIVEL MP EYE COUPLER
AND TILT
TRUSS SUPPORT 150-250

 6.1lbs
  28mm
 1" 1/8

Truss Support Coupler with a tilt/swivel connection to the stand pin. It avoids torsion and mounting problems when lifting a truss using two stands simultaneously. Min. length 5.9in. Max. length 9.8in.

C4482
SWIVEL
MP EYE COUPLER

 1.8lbs

Twin couplers free to rotate 360° for firm, quick and easy coupling of trusses, bars or pipes.



C4486
SWIVEL MP EYE COUPLER
AND TILT
TRUSS SUPPORT 200-400

 6.3lbs
  28mm
 1" 1/8

Min. length 7.9in. Max. length 15.7in.

MP SLIM EYE COUPLERS: same features as MP coupler, but narrower in profile and lighter in weight.

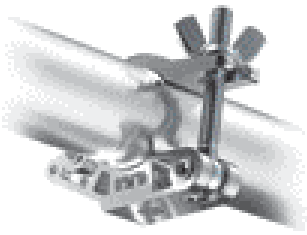
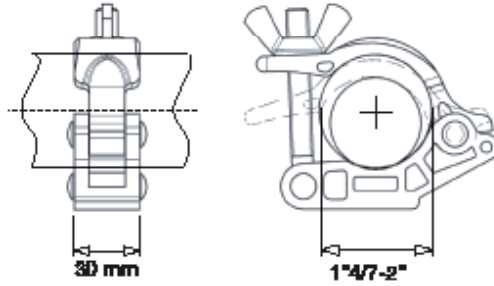

C4560
SLIM MP EYE COUPLER

- 0.6lbs
- 660lbs
- 0.51in hole

The base model of MP slimlight version Eye Coupler.



C4564
MP EYE COUPLER
12MM BOLT + NUT

- 0.7lbs
- 660lbs
- M12x27mm





Supplied with M12 bolt and nut for custom solutions.



TELESCOPIC HANGER SYSTEM

C825





TELESCOPIC HANGER WITH UNIVERSAL HEAD

				
47.6in	79.1in	11lbs	28mm 1" 1/8	16mm 5/8"

Max load with 5/8in spigot 22lbs.
Max load with 1.8in socket 88lbs.

C827



LONG TELESCOPIC HANGER WITH UNIVERSAL HEAD

				
83.5in	150in	15lbs	28mm 1" 1/8	16mm 5/8"

Max load with 5/8in spigot 22lbs.
Max load with 1.8in socket 88lbs.

C820





TELESCOPIC HANGER WITH STIRRUP

			
46.1in	77.6in	11.9lbs	88lbs

Luminaire attachment - Stirrup Ø 1.6in.

C822

LONG TELESCOPIC HANGER WITH STIRRUP

			
82.7in	149.2in	15lbs	88lbs

Luminaire attachment - Stirrup Ø 1.6in.



C888UH

TELESCOPIC HANGER WITH UNIVERSAL HEAD



29.9lbs



63.4lbs



10.1lbs



28mm
1" 1/8"



16mm
5/8"

Max load with 5/8" spigot 22lbs.
Max load with 1.8" socket 88lbs.



C888ST

TELESCOPIC HANGER WITH STIRRUP



28.7lbs



61.8lbs



10.3lbs



88lbs

Luminaire attachment - Stirrup Ø 1.6lbs.



C820-0111

TELESCOPIC HANGER WITH STIRRUP



34.6lbs



77.6lbs



10.1lbs



88lbs

Luminaire attachment - Stirrup Ø 1.6".



LIGHTING BOOMS SYSTEM



D570 B

EXTENSION ARM WITH SWIVEL PIN

2.4lbs 16mm
5/8"

Arm length: 35.8in.
5/8in female stand attachment.



D600 CB

MINI BOOM

7.9lbs 16mm
5/8"

Min extension 46in - Max load 66lbs.
Max extension 83.4in - Max load 15.4lbs.
5/8in female stand attachment.



D650

JUNIOR BOOM ARM

32.5lbs 28mm 16mm
1" 1/8 5/8"

Min extension 64.2in - Max load 88lbs.
Max extension 118in - Max load 22lbs.
5/8in female stand attachment.

PRODUCT BELOW IS AVAILABLE AS OPTIONAL



172
MINI
COUNTERWEIGHT

2.9lbs



022
G-PESO

14.7lbs

023
L-PESO

9.5lbs



CROSSPOLE SYSTEM



X400KIT CROSSPOLE KIT

31.5in up to 13.1 feet Crosspole kit
components: Expander, Static Plate,
Double Locking
Collar, 3 tubes \varnothing 45mm, 3 tubes \varnothing 50mm
and multifunctional bag.

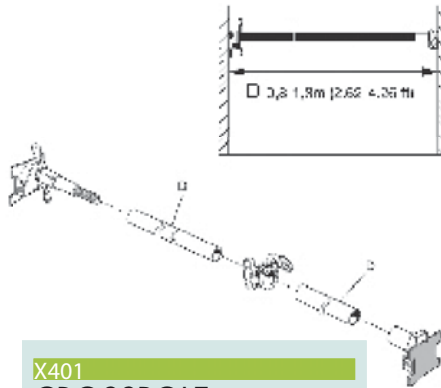

X401 CROSSPOLE

31.5in up to 51.2in Crosspole kit
components: Expander, Static Plate,
Double Locking
Collar, 1 tube \varnothing 45mm, 1 tube \varnothing 50mm.

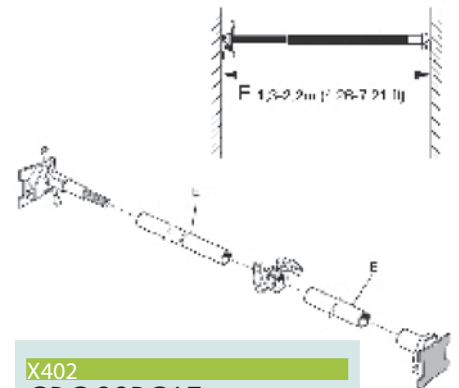

X402 CROSSPOLE

50.1in up to 86.6in Crosspole kit
components: Expander, Static Plate,
Double Locking
Collar, 1 tubes \varnothing 45mm, 1 tube \varnothing 50mm.

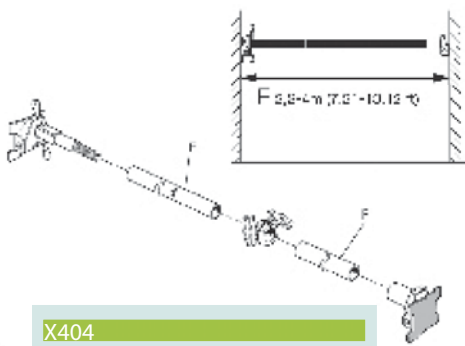

X404 CROSSPOLE

86.2in up to 13.1 feet Crosspole
components: Expander, Static Plate,
Double Locking
Collar, 1 tube \varnothing 45mm, 1 tube \varnothing 50mm.

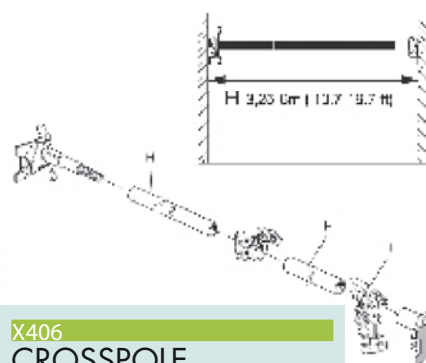

X406 CROSSPOLE

19.7 feet Crosspole components:
Expander, Static Plate, Double Locking
Collar, 1 tube \varnothing 45mm, 1 tube \varnothing 50mm +
Cross Coupler.

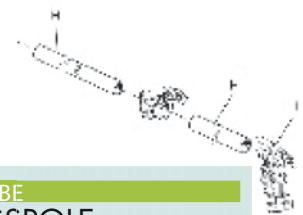

X406TUBE CROSSPOLE

Tubes and accessories for 19.7 feet
application components 1 tube diam.
45mm, 1 tube diam. 50mm, Cross Coupler,
Locking Collar.



TUBES

Eight tubes in special aluminum to cover the distance between two walls up to 6 meters (3mt tubes as accessories)



CROSS COUPLER

Dedicated component to create a combination of two or more Crosspole.



LOCKING COLLAR

Dedicated component that prevents the tube from sliding. Provided with aluminum handle grips and rubber covers.



Special component that permits the bending of the tubes and guarantees the maximum grip with your wall. Provided with leveling bubble and assembled with bolts (no rivets).



Innovative and patented component that permits the bending of the tubes and, using the automatic index, the pre-loading of the CrossPole. Designed to guarantee the maximum safety and resistance for the working life. Made by special aluminum and steel, provided with leveling bubble and assembled with bolts (no rivets).



Versatile bag provided with a multipocket system to contain and protect all the components of the CrossPole kit.

ARMS SYSTEM



F900
BABY TRIPLE HEADER
5X5/8" PIN / 5/8" SOCKET

 2.9lbs
 Length: 25.6in.



169
FIVE SOCKET BRACKET

 13.4lbs  28mm 1" 1/8  28mm 1" 1/8  110lbs*

39.3in long T Bar with 5x1 1/8in sockets for attaching up to 5 lighting fixtures. Designed to fit on stand or bracket with 1 1/8in socket. *When load on one side only, max load capacity: 33lbs.



F700
BABY SIDE ARM TWIN
5/8" PIN

 4.6lbs
 Length: 14.9in.





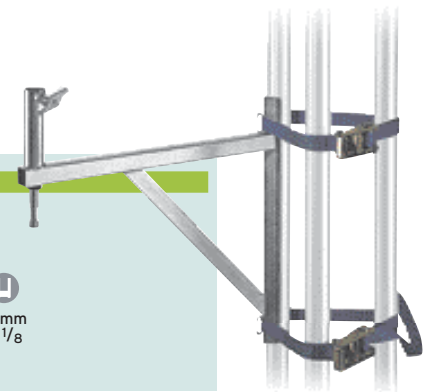

F200
JUNIOR ADJUSTABLE
SIDE ARM 1" 1/8 SOCKET

 4.6lbs
 Length: 16.1in.



F1200
COLUMN ARM

 6.8lbs  55lbs  16mm 5/8"  28mm 1" 1/8

Length: 20in.

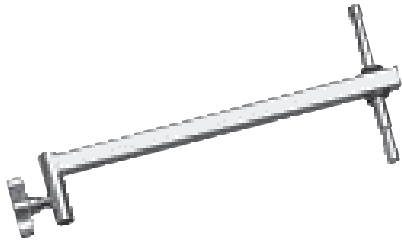

F600
BABY OFFSET ARM/TWIN
5/8" PIN / 5/8" SOCKET

 15lbs
 Length: 14.9in.





F100
JUNIOR OFFSET ARM
1/8" PIN / 1/8" SOCKET

 3.3lbs
 Length: 19.7in.



C330
FIXED BABY SIDE ARM

 3lbs
 66lbs
 16mm
 5/8"

Clamps on diameters from 1.9in to 2in.
 Length: 17.3in.



C335
FIXED JUNIOR SIDE ARM

 3.1lbs
 44lbs
 28mm
 1" 1/8"

Clamps on diameters from 1.9in to 2in.
 Length: 18.5in.

BRACKETS AND BARS **SYSTEM**



D301

SNAP IN ARTICULATED ARM

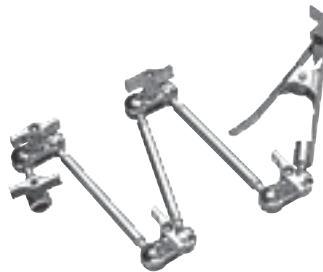

S  
0.2lb 0.77lbs

Length: 30.7in.



D300

ARTICULATED ARM WITH SPRING CLAMP

S  
1.9lbs 0.55lbs

Length: 35.9in.

D306

ARTICULATED ARM WITH HEXAGONAL END

Similar to the D301 but with a hexagonal attachment at one end and a 5/8in pin at the other.

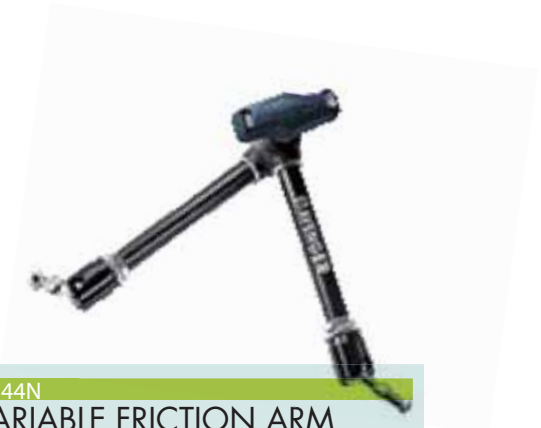

D244N

VARIABLE FRICTION ARM

- 2.4lbs
- 16mm
5/8"
- 16mm
5/8"
- 6.6lbs

Articulated arm with large locking knob to lock all 3 movements.



D310

MINI FLEX ARM

- 0.2lbs

Flexible arm, \varnothing 3/8". Length: 4.3in.
Attachment bushing and stud 1/4-20in diam.



D315

MAXI FLEX ARM

- 0.4lbs

Flexible arm, \varnothing 0.59". Length: 4.9in.
Attachment bushing and stud 3/8in diam.

PUMP CUP SYSTEM



F1000
PUMP CUP WITH 5/8" BABY SWIVEL SPIGOT

 2.6lbs
  4.4lbs
  16mm 5/8"

Ideal for mounting small lights and camera systems onto flat, non-porous surfaces such as glass. A perfect tool for rigging car shoots





F1100
PUMP CUP WITH 5/8" BABY FIXED SPIGOT

 1.5lbs
  4.4lbs
  16mm 5/8"

Like the F1000, but with a fixed baby pin for added stability.





F809
BABY PLATE WITH 90° PIN

 1.4lbs
  5/8in

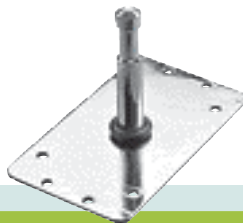
When a light stand or a clamp cannot be used to support fixtures, this baby plate with a right angle can be mounted on the wall.





F800
3" BABY WALL PLATE

 0.9lbs
  16mm 5/8"

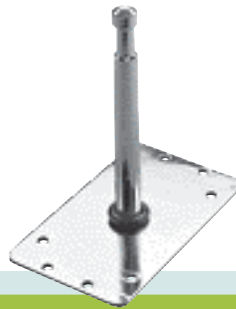
Baby plates allow for the quick mounting of fixtures in places where light stands and clamps cannot be used. Length 3in.



F805
6" BABY WALL PLATE

 1.6lbs
  16mm 5/8"

Baby plates allow for the quick mounting of fixtures in places where light stands and clamps cannot be used. Length 6in.



F808
9" BABY WALL PLATE

 1.9lbs
  16mm 5/8"

Baby plates allow for the quick mounting of fixtures in places where light stands and clamps cannot be used. Length 9in.



F301
BABY WALL PLATE

1.2lbs 16mm
5/8"

Baby plates allow for the quick mounting of fixtures in places where light stands and clamps cannot be used.

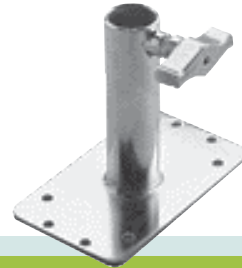

F300
JUNIOR WALL PLATE

1.5lbs 28mm
1" 1/8"

A wall plate with a junior receiver to mount larger fixtures.

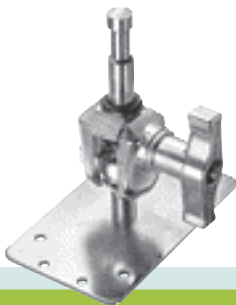

F810
BABY PLATE WITH 5/8" SWIVEL SPIGOT

1.8lbs 16mm
5/8"

Unique to the Avenger line, this baby plate allows fixtures to be fine-tuned with the built in swiveling baby pin.



F815
BABY PLATE "T" PIN

2.1lbs 16mm
5/8"

Height 15in.

ACCESSORIES





Modularity: this is the key word representing this family. All Avenger products allow a high level of customization, find here everything you need to adapt a product to another one, creating your tailored solution.

ACCESSORIES

027 STAND HOLDER



6.2lbs

Holder for 8 light stands.
Width: 45.2in.
Distance between fixing holes: 25.3in.
Depth: 7.5in.



A9000 BRAKED WHEELS



7.3lbs



198lbs

Ø: 100mm for 25x25mm
square legs. Set of three.

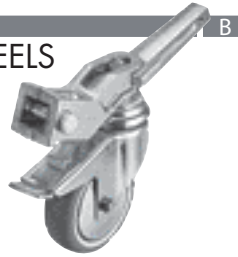

C155 SAFETY CABLE

Diameter 0.16in. Length 39.3in.

C155-01 SAFETY CABLE

Diameter 0.1in. Length 27.6in.

C155-02 SAFETY CABLE

Diameter 0.2in. Length 27.6in.

C155-03 SAFETY CABLE

Diameter 0.2in. Length 39.3in.

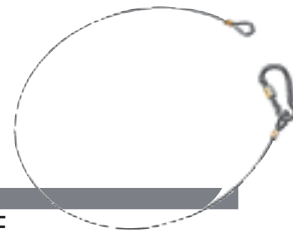

5/8" FEMALE ADAPTERS

All measurements shown are metric unless otherwise stated.

5/8" Indicates an external thread or stud diameter

5/8" Indicates an internal thread or socket diameter

W Whitworth thread

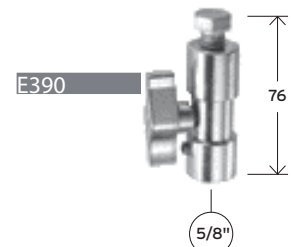
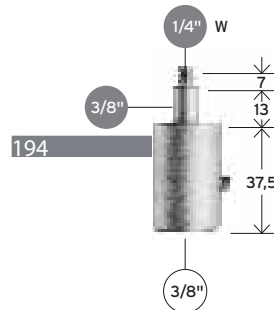
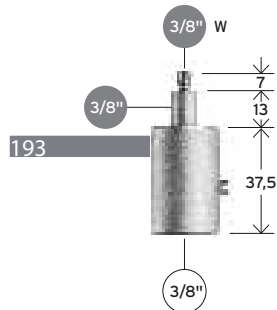
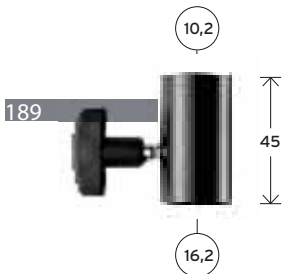
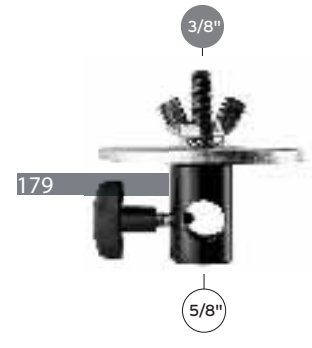
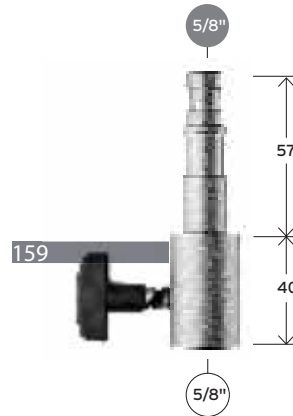
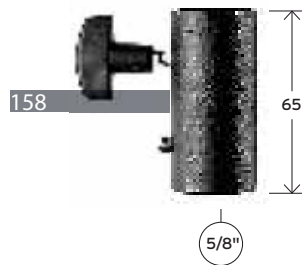
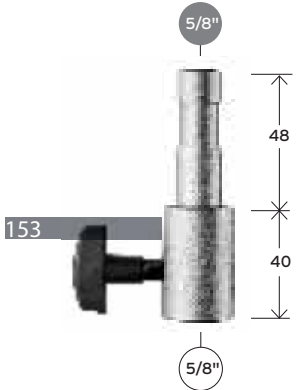
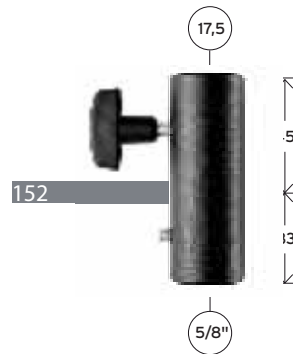
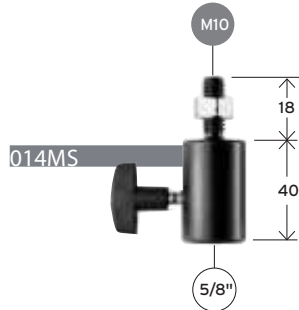
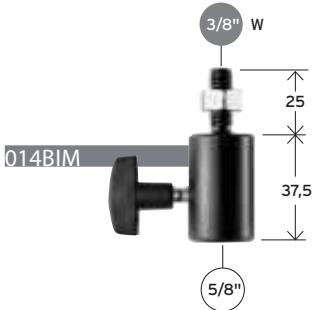
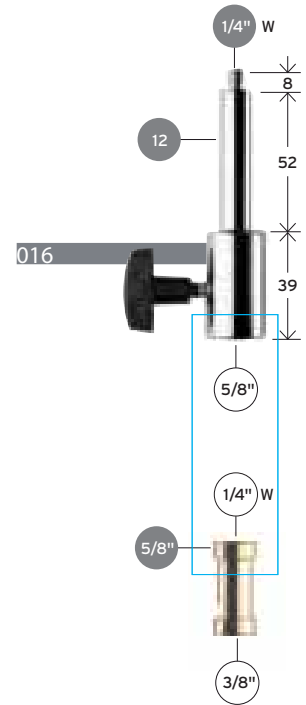
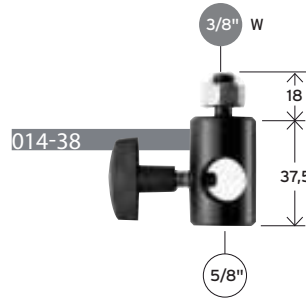
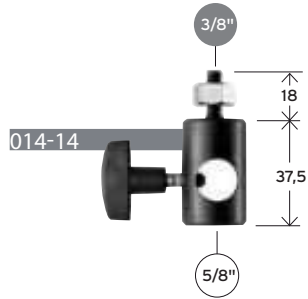

5/8" MALE ADAPTERS

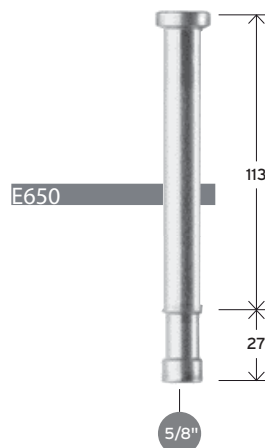
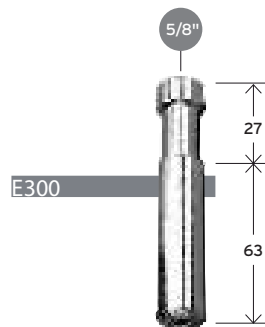
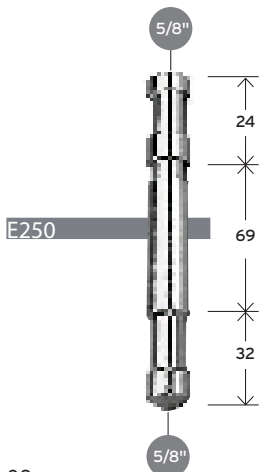
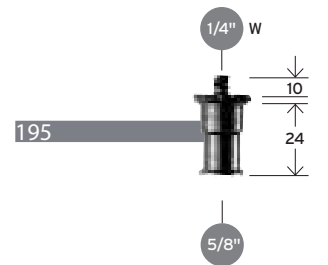
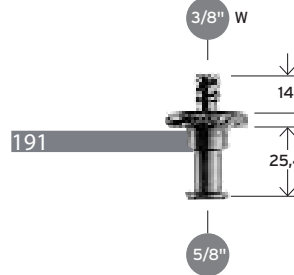
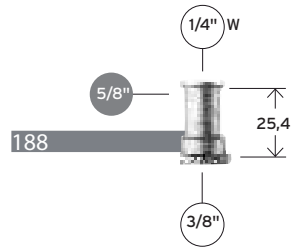
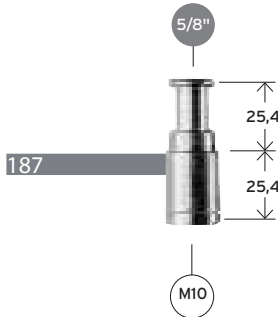
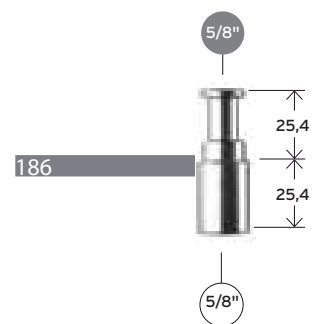
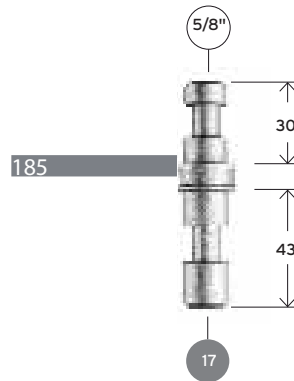
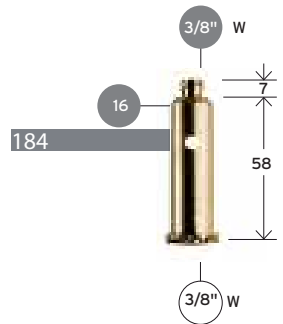
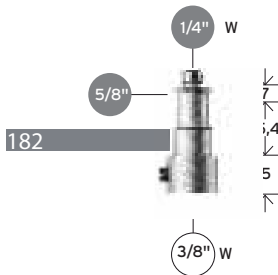
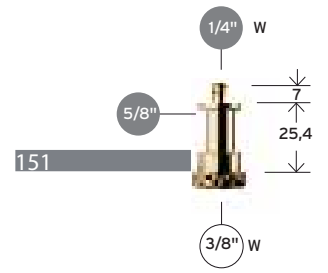
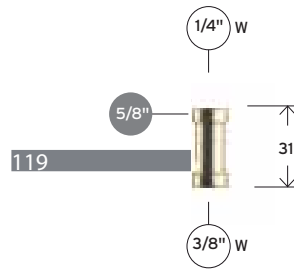
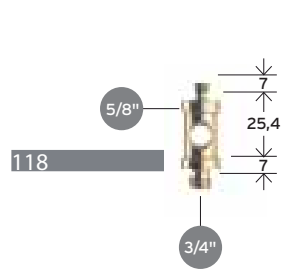
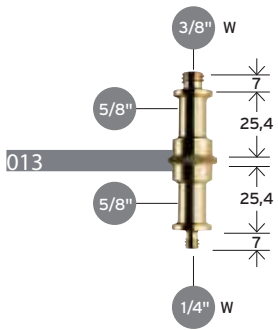

1" 1/8 MALE ADAPTERS

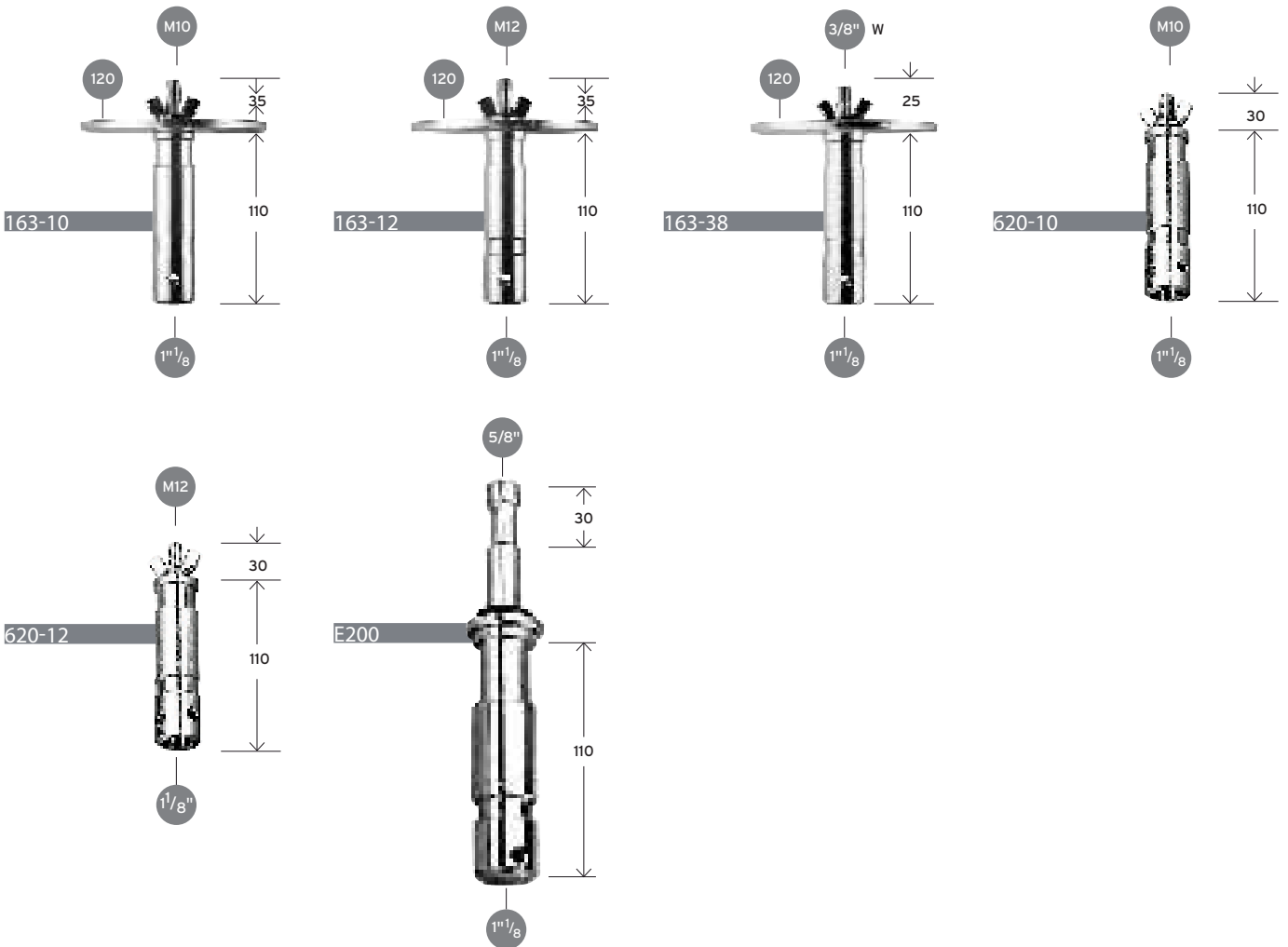

SPECIAL ADAPTERS

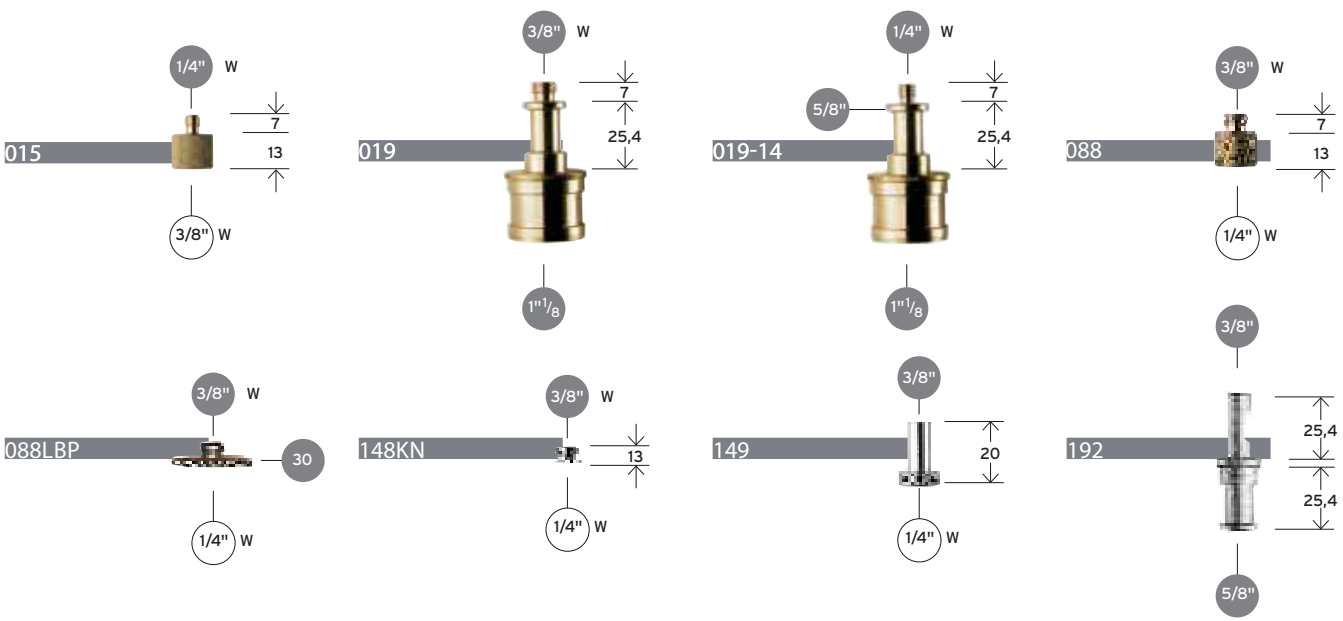

SPECIAL ADAPTERS

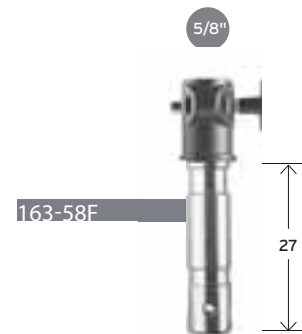
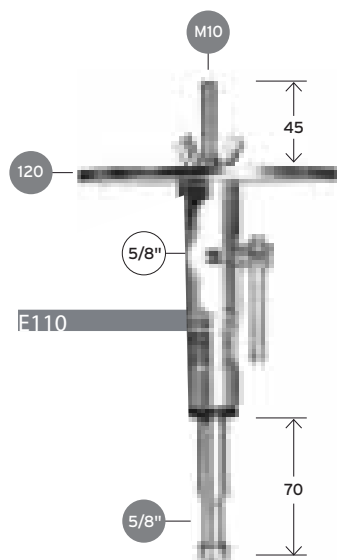
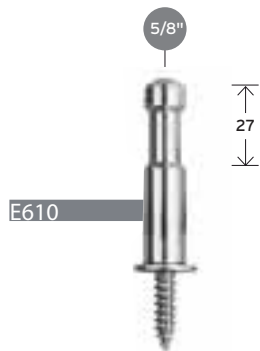
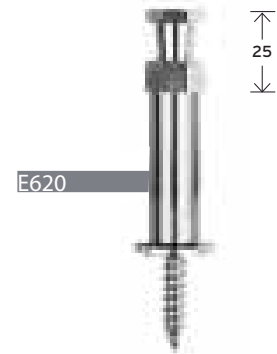
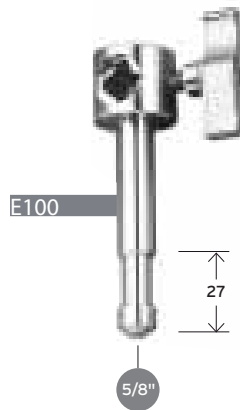
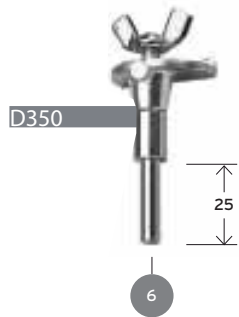
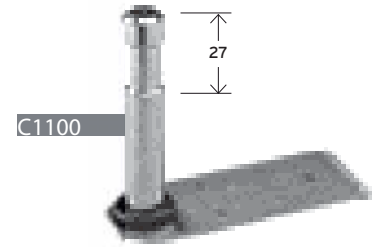
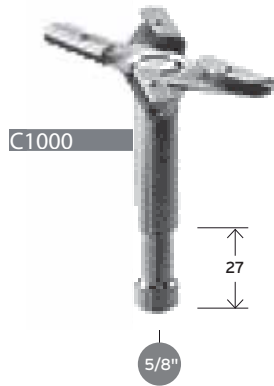

SUPER CLAMP ADAPTERS

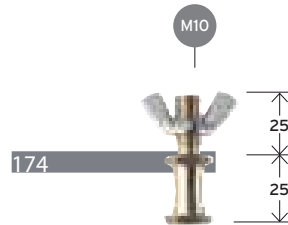
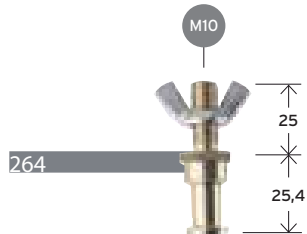
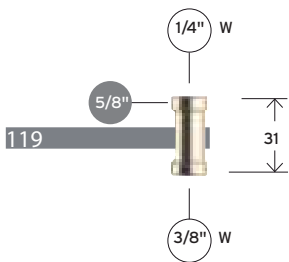
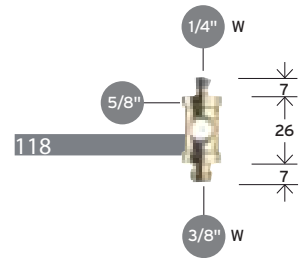
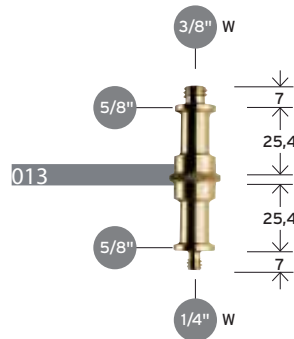
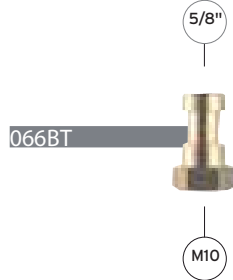
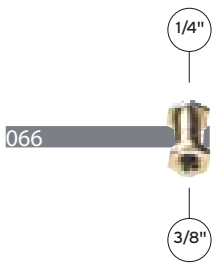
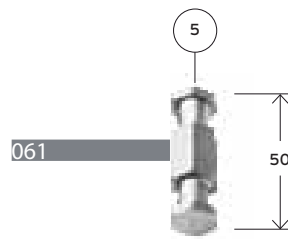
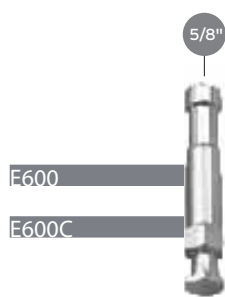
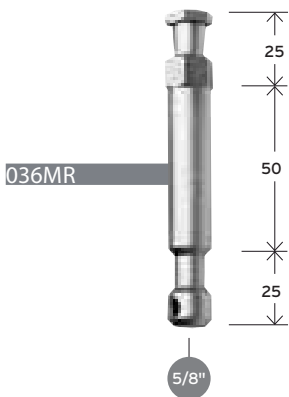
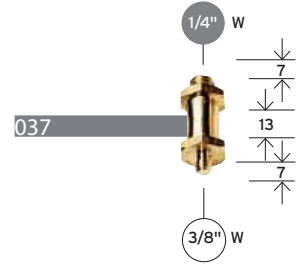
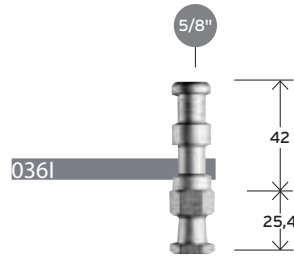
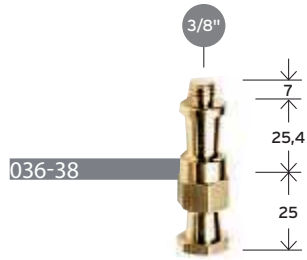
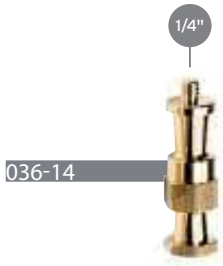

SWIVELING ADAPTERS

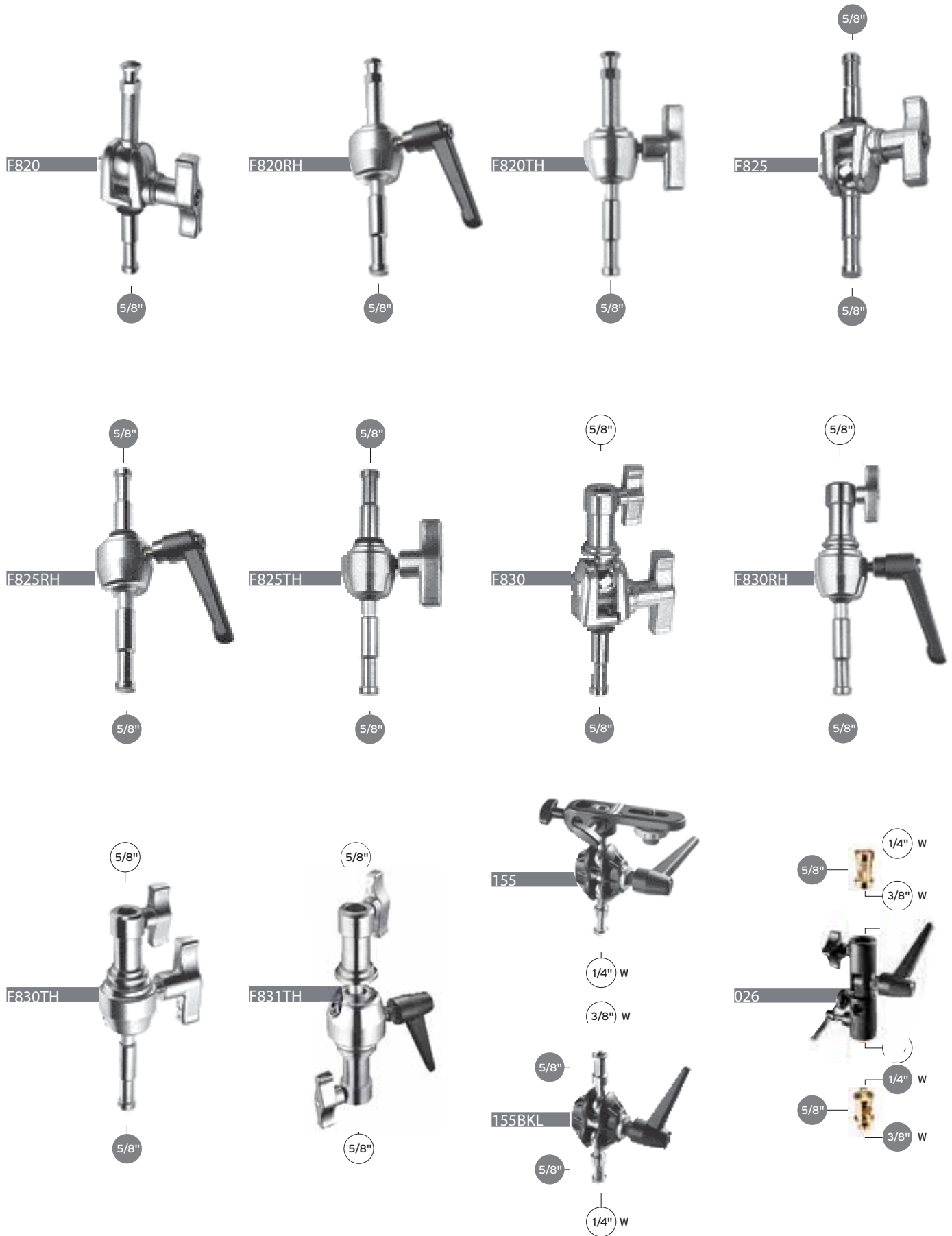

INDEX

art	description	page	art	description	page	art	description	page
013	5/8" MALE SUPER CLAMP ADAPTER	82-85	A2016D	C-STAND 16 DETACHABLE	14	C345	BARREL CLAMP	61
014-14	5/8" FEMALE ADAPTER	81	A2016DCB	CHROME BLACK C-STAND 16 DETACHABLE	14	C345K	BARREL CLAMP	59
014-38	5/8" FEMALE ADAPTER	81	A2018F	C-STAND 18	13	C4460	MP EYE COUPLER	59
014BIM	5/8" FEMALE ADAPTER	81	A2018FCB	CHROME BLACK C-STAND 18	13	C4461	MP EYE COUPLER WITH 1 1/8" TV SPIGOT	62
014MS	5/8" FEMALE ADAPTER	81	A2018L	C-STAND 18 SLIDING LEG	13	C4462	MP EYE COUPLER WITH 5/8" SPIGOT	62
015	SPECIAL ADAPTER	83	A2018LCB	CHROME BLACK C-STAND 18 SLIDING LEG	13	C4463	MP EYE COUPLER WITH LIFTING RING	62
016	5/8" FEMALE ADAPTER	81	A2020	C-STAND COLUMN 20	15	C4464	MP EYE COUPLER WITH M12 BOLT + NUT	62
019	SPECIAL ADAPTER	83	A2020CB	CHROME BLACK C-STAND COLUMN 20	15	C4465	MP EYE COUPLER WITH 1 1/8" BUSHING	62
019-14	SPECIAL ADAPTER	83	A2022D	C-STAND 22 DETACHABLE	14	C4469	MP EYE COUPLER WITH 5/8" BUSHING	62
022	G-PESO	69	A2022DCB	CHROME BLACK C-STAND 22 DETACHABLE	14	C4470	TILT & SWIVEL MP EYE COUPLER	64
023	L-PESO	69	A2025F	C-STAND 25	13	C4482	SWIVEL MP EYE COUPLER	64
026	SWIVELING ADAPTER	86	A2025FCB	CHROME BLACK C-STAND 25	13	C4485	SWIVEL AND TILT TRUSS SUPPORT 150-250	64
027	STAND HOLDER	39-80	A2025L	C-STAND 25 SLIDING LEG	13	C4486	SWIVEL AND TILT TRUSS SUPPORT 200-400	64
036-14	SUPER CLAMP ADAPTER	85	A2025LCB	CHROME BLACK C-STAND 25 SLIDING LEG	13	C4560	SLIM MP EYE COUPLER	65
036-38	SUPER CLAMP ADAPTER	85	A2029	C-STAND COLUMN 29	15	C4564	MP EYE COUPLER WITH M12 BOLT PLUS NUT	65
036I	SUPER CLAMP ADAPTER	85	A2029CB	CHROME BLACK C-STAND COLUMN 29	15	C500	PELICAN GAFFER GRIP	55
036MR	SUPER CLAMP ADAPTER	85	A2030D	C-STAND 30 DETACHABLE	14	C590	CONKA BONKA	38
037	SUPER CLAMP ADAPTER	85	A2030DCB	CHROME BLACK C-STAND 30 DETACHABLE	14	C595	BABY BONKA	38
061	SUPER CLAMP ADAPTER	85	A2030DKIT	C-STAND KIT 30 DETACHABLE	12	C622	SMALL STEEL STAND EXTENSION	38
061RA	SUPER CLAMP ADAPTER	85	A2033F	C-STAND 33	13	C624	MEDIUM STEEL STAND EXTENSION	38
066	SUPER CLAMP ADAPTER	85	A2033FCB	CHROME BLACK C-STAND 33	13	C626	LONG STEEL STAND EXTENSION	38
066BT	SUPER CLAMP ADAPTER	85	A2033FKIT	C-STAND KIT 33	12	C820	TELESCOPIC HANGER WITH STIRRUP	66
087WBK	WIND-BRACING KIT	39	A2033L	C-STAND 33 SLIDING LEG	13	C820-0111	TELESCOPIC HANGER WITH STIRRUP	67
088	SPECIAL ADAPTER	83	A2033LCB	CHROME BLACK C-STAND 33 SLIDING LEG	13	C822	LONG TELESCOPIC HANGER WITH STIRRUP	67
088LBP	SPECIAL ADAPTER	83	A2033LKIT	C-STAND KIT 33 SLIDING LEG	12	C825	TELESCOPIC HANGER WITH UNIVERSAL HEAD	67
118	5/8" MALE SUPER CLAMP ADAPTER	82-85	A3042CS	CHROME STEEL OVERHEAD STAND 42	36	C827	LONG TELESCOPIC HANGER WITH UNIVERSAL HEAD	67
119	5/8" MALE SUPER CLAMP ADAPTER	82-85	A3043CS	CHROME STEEL OVERHEAD STAND 43	36	C888ST	TELESCOPIC HANGER WITH STIRRUP	66
143F	FORK	43		WITH BRAKED WHEELS		C888UH	TELESCOPIC HANGER WITH UNIVERSAL HEAD	66
143FD	DOUBLE FIXED FORK	43	A3056CS	CHROME STEEL WIDE BASE OVERHEAD STAND 56	37	D050	SET OF 6 BLUE T-TOPS	19
143FV	DOUBLE HINGED FORK	43	A3058CS	CHROME STEEL OVERHEAD STAND 58	36	D050B	SET OF 6 BLACK T-TOPS	19
148KN	SPECIAL ADAPTER - SET OF 5	83		WITH BRAKED WHEELS		D050G	SET OF 6 GREY T-TOPS	19
149	SPECIAL ADAPTER	83	A3059CS	CHROME STEEL OVERHEAD STAND 59	36	D050LB	SET OF 6 LIGHT BLUE T-TOPS	19
151	5/8" MALE ADAPTER	82	A3065CS	CHROME STEEL WIDE BASE OVERHEAD STAND 65	37	D050R	SET OF 6 RED T-TOPS	19
152	5/8" FEMALE ADAPTER	81	A4039CS	CHROME STEEL BOOM STAND 39	26	D050Y	SET OF 6 YELLOW T-TOPS	19
153	5/8" FEMALE ADAPTER	81	A4041B	BLACK ALU BOOM STAND 41	26	D100	DOUBLE GRIP HEAD	18
155	SWIVELING ADAPTER	86	A4050CS	CHROME STEEL BOOM STAND 50	27	D100B	BLACK DOUBLE GRIP HEAD	18
155BKL	SWIVELING ADAPTER	86	A5012	ROLLER STAND 12 FOLDING BASE	25	D200	2" 1/2 GRIP HEAD	18
158	5/8" FEMALE ADAPTER	81	A5017	ROLLER STAND 17 FOLDING BASE	24	D200B	BLACK 2" 1/2 GRIP HEAD	18
159	5/8" FEMALE ADAPTER	81	A5029	ROLLER STAND 29 LOW BASE	24	D210	SNAP-IN GRIP HEAD	18
163-10	1" 1/8 MALE ADAPTER	83	A5033	ROLLER STAND 33 FOLDING BASE	24	D210B	BLACK SNAP-IN GRIP HEAD	18
163-12	1" 1/8 MALE ADAPTER	83	A5034	ROLLER STAND 34 FOLDING BASE	25	D220	GRIP HELPER	18
163-38	1" 1/8 MALE ADAPTER	83	A5036CS	CHROME STEEL ROLLER STAND 36 LOW BASE	25	D220B	BLACK GRIP HELPER	18
163-58F	SPECIAL ADAPTER	84	A5042CS	CHROME STEEL ROLLER STAND 42 LOW BASE	25	D230	SUPER CLAMP GRIP HEAD	18
169	FIVE SOCKET BRACKET	72	A5043	ROLLER STAND 43 LOW BASE	24	D240	GRIP HEAD WITH SWIVEL PIN	18
172	MINI COUNTERWEIGHT	69	A9000	BRAKED WHEELS	22-27-39-80	D240B	BLACK GRIP HEAD WITH SWIVEL PIN	18
174	SUPER CLAMP ADAPTER	85	A9000B	BLACK BRAKED WHEELS	22-27-39-80	D244	VARIABLE FRICTION ARM	75
179	5/8" FEMALE ADAPTER	81	AWG5200	CORDURA SAND BAG	39	D250	GAG GOBO	18
182	5/8" MALE ADAPTER	82	AWG5202	CORDURA SAND BAG	39	D250B	BLACK GAG GOBO	18
184	5/8" MALE ADAPTER	82	B6026CS	CHROME STEEL WIND UP STAND 26	28	D260	ADDA HEAD	18
185	5/8" MALE ADAPTER	82	B6029X	STAINLESS STEEL SUPER WIND UP 29 LOW BASE	30	D260B	BLACK ADDA HEAD	18
186	5/8" MALE ADAPTER	82	B6030CS	CHROME STEEL WIND UP STAND 30 LOW BASE	29	D300	ARTICULATED ARM WITH SPRING CLAMP	74
187	5/8" MALE ADAPTER	82	B6039CS	CHROME STEEL WIND UP STAND 39	29	D301	SNAP-IN ARTICULATED ARM	74
188	5/8" MALE ADAPTER	82	B6040X	STAINLESS STEEL SUPER WIND UP 40	31	D306	ARTICULATED ARM WITH HEXAGONAL END	74
189	5/8" FEMALE ADAPTER	81	B7018	STRATO SAFE STAND 18	32	D310	MINI FLEX ARM	75
191	5/8" MALE ADAPTER	82	B7035CS	CHROME STEEL STRATO SAFE STAND 35	32	D315	MAXI FLEX ARM	75
192	SPECIAL ADAPTER	83	B7043CS	CHROME STEEL STRATO SAFE STAND 43	33	D340	CAMERA FLEXTENTION KIT	42
193	5/8" FEMALE ADAPTER	81	B7047CS	CHROME STEEL STRATO SAFE STAND 47	33	D350	SPECIAL ADAPTER	84
194	5/8" FEMALE ADAPTER	81	B7057	LONG JOHN SILVER STAND	35	D390	UNIVERSAL FLEXTENTION KIT	42
195	5/8" MALE ADAPTER	82	B7057FF	LONG JOHN SILVER STAND WITH FOAM FILL WHEELS	35	D400	4" 1/2 JUMBO GRIP HEAD	19-22
264	SUPER CLAMP ADAPTER	85	C100	JUNIOR PIPE CLAMP WITH 28MM SOCKET	56	D400B	BLACK 4" 1/2 JUMBO GRIP HEAD	19-22
620-10	1" 1/8 MALE ADAPTER	83	C1000	SPECIAL ADAPTER	84	D420	JUMBO GAG GOBO	19
620-12	1" 1/8 MALE ADAPTER	83	C1005	SPECIAL ADAPTER	84	D420B	BLACK JUMBO GAG GOBO	19
A0003	BACKLITE BABY STAND	20	C1100	SPECIAL ADAPTER	84	D500	20" EXTENSION GRIP ARM	19
A0010	BABY STAND 10	20	C150	SWIVELING "C" CLAMP	57	D500B	BLACK 20" EXTENSION GRIP ARM	19
A0017	BABY STAND 17	20	C151	SWIVELING "C" CLAMP WITH M12 SCREW	57	D520	40" EXTENSION GRIP ARM	19
A0025B	ALU BABY STAND 25	20	C155	SAFETY CABLE	54-80	D520B	BLACK 40" EXTENSION GRIP ARM	19
A0030B	BLACK ALU BABY STAND 30	21	C-1525	SKY HOOK	55	D550	FUN GRIP ARM	19
A0030CS	CHROME STEEL BABY STAND 30	21	C1550	HEAVY DUTY SUPER CLAMP	54	D550B	BLACK FUN GRIP ARM	19
A0035B	BLACK ALU BABY STAND 35	21	C155-01	SAFETY CABLE	54-80	D560	BALL AND SOCKET FLAG ARM	43
A0035CS	CHROME STEEL BABY STAND 35	21	C155-02	SAFETY CABLE	54-80	D570	EXTENSION ARM WITH SWIVEL PIN	68
A0040B	BLACK ALU BABY STAND 40	21	C155-03	SAFETY CABLE	54-80	D570B	BLACK EXTENSION ARM WITH SWIVEL PIN	68
A0040CS	CHROME STEEL BABY STAND 40	21	C1575B	SUPER CLAMP	54	D580	UNIVERSAL ARTICULATED ARM KIT	42
A0045B	BLACK ALU BABY STAND 45	21	C210	BABY PIPE CLAMP WITH 16MM STUD	55	D600	MINI BOOM	68
A0045CS	CHROME STEEL BABY STAND 45	21	C280	STAGE CLAMP	56	D600CB	CHROME BLACK MINI BOOM	68
A1010CS	CHROME STEEL COMBO STAND 10	22	C285	STAGE CLAMP WITH 16MM STUD	60	D610	C-BOOM/FISHPOLE HOLDER	37
A1020B	BLACK ALU COMBO STAND 20	22	C290	STAGE CLAMP WITH 28MM STUD	60	D650	JUNIOR BOOM ARM	68
A1020CS	CHROME STEEL COMBO STAND 20	22	C295	STAGE CLAMP WITH 28MM SOCKET	60	D700B	COLLAPSIBLE REFLECTOR HOLDER	45
A1035B	BLACK ALU COMBO STAND 35	22	C330	FIXED BABY SIDE ARM	60	D705B	COLLAPSIBLE REFLECTOR HOLDER LONG	45
A1035CS	CHROME STEEL COMBO STAND 35	22	C335	FIXED JUNIOR SIDE ARM	73	D750	40MM (1.6") TELESCOPIC POLYHOLDER	44
A1045B	BLACK ALU COMBO STAND 45	22	C337	QUICK ACTION JUNIOR CLAMP 28MM BUSHING	73	D800KIT	GRIP KIT	19
A1045CS	CHROME STEEL COMBO STAND 45	22	C338	QUICK ACTION BABY CLAMP 16MM PIN	58	E100	SPECIAL ADAPTER	84
A2007	C-STAND MINI BASE	15	C339	GRAB CLAMP	58	E110	SPECIAL ADAPTER	84
A2007CB	BLACK CHROME C-STAND MINI BASE	15	C339BB	GRAB CLAMP WITH 16MM BUSHING	61	E200	1" 1/8 MALE ADAPTER	83
A2009	C-STAND BASE	15	C339J5	GRAB CLAMP WITH 28MM TV SPIGOT	61	E250	5/8" MALE ADAPTER	82
A2009CB	BLACK CHROME C-STAND BASE	15	C339LE	GRAB CLAMP WITH LIFTING EYE	61			
A2014	C-STAND COLUMN 14	15	C339SP	GRAB CLAMP WITH SPINNING PULLEY	61			
A2014CB	BLACK CHROME C-STAND COLUMN 14	15	C339UH	DOUBLE GRAB CLAMP WITH UNIVERSAL HEAD	61			

art	description	page
E300	5/8" MALE ADAPTER	82
E390	5/8" FEMALE ADAPTER	81
E600	SNAP-IN PIN FOR SUPER CLAMP	19-54-85
E600C	STEEL SNAP-IN PIN FOR SUPER CLAMP	19-54-85
E610	SPECIAL ADAPTER	84
E620	SPECIAL ADAPTER	84
E650	5/8" MALE ADAPTER	85
E700	BABY DROP DOWN PIN	27
E710	JUNIOR DROP DOWN PIN	27
F100	JUNIOR OFFSET ARM 28MM PIN 28MM SOCKET	73
F1000	PUMP CUP WITH 16MM BABY SWIVEL SPIGOT	76
F1100	PUMP CUP WITH 16MM BABY FIXED SPIGOT	76
F1200	COLUMN ARM	72
F1501	30MM (1.2") POLYHOLDER	44
F1504	FOAMCORE FORK 16MM PIN	43
F1520	50MM (2") POLYHOLDER WITH SWIVEL JOINT 1" 1/8 SPIGOT	44
F1521	50MM (2") POLYHOLDER WITH 16MM SPIGOT	44
F200	JUNIOR ADJUSTABLE SIDE ARM 28MM SOCKET	72
F300	JUNIOR WALL PLATE	77
F301	BABY WALL PLATE	77
F600	BABY OFFSET ARM TWIN 16MM PIN 16MM SOCKET	73
F700	BABY SIDE ARM TWIN 16MM PIN	72
F800	3" BABY WALL PLATE	76
F805	6" BABY WALL PLATE	76
F808	9" BABY WALL PLATE	76
F809	BABY PLATE WITH 90° PIN	76
F810	BABY PLATE WITH 16MM SWIVEL SPIGOT	77
F815	BABY PLATE "T" PIN	77
F820	SWIVELING ADAPTER	86
F820RH	SWIVELING ADAPTER	86
F820TH	SWIVELING ADAPTER	86
F825	SWIVELING ADAPTER	86
F825RH	SWIVELING ADAPTER	86
F825TH	SWIVELING ADAPTER	86
F830	SWIVELING ADAPTER	86
F830RH	SWIVELING ADAPTER	86
F830TH	SWIVELING ADAPTER	86
F831TH	SWIVELING ADAPTER	86
F900	BABY TRIPLE HEADER 5X16MM PIN 16MM SOCKET	72
G100	SMALL SAND BAG	39
G200	LARGE SAND BAG	39
H1200M	MODULAR FRAME 6X6'	48
H1220EXT	MODULAR FRAME CONVERSION KIT FROM 12X12' TO 20X20'	49
H2000M	MODULAR FRAME 20X20'	48
H2006	FOLD AWAY FRAME 6X6'	46
H2008	FOLD AWAY FRAME 8X8'	46
H2012	FOLD AWAY FRAME 12X12'	46
H2508	FOLD AWAY FRAME COMPACT 8X8'	47
H2512	FOLD AWAY FRAME COMPACT 12X12'	47
H400M	MODULAR FRAME 4X4'	48
H406EXT	MODULAR FRAME CONVERSION KIT FROM 4X4' TO 6X6'	48
H408EXT	MODULAR FRAME CONVERSION KIT FROM 4X4' TO 8X8'	48
H440	LIGHTWEIGHT FRAME 4X4'	48
H600M	MODULAR FRAME 6X6'	48
H660	LIGHTWEIGHT FRAME 6X6'	48
H6BAG	FRAME BAG	48
H800M	MODULAR FRAME 8X8'	48
H806EXT	MODULAR FRAME CONVERSION KIT FROM 20X20', 12X12' AND 8X8' TO 6X6''	49
H812EXT	MODULAR FRAME CONVERSION KIT FROM 8X8' TO 12X12'	49
H9000	D.I.Y. BUTTERFLY PIPE CORNER KIT 1" 1/2	49
H9500	D.I.Y. BUTTERFLY PIPE CORNER KIT 1" 1/4	49
I800	BLACK METAL FLAG	42
I8030CB	MOUNTING STIRRUP FOR 40" REFLECTOR BOARD	45
I810	BLACK PLASTIC FLAG	42
X400KIT	CROSSPOLE KIT	70
X401	CROSSPOLE	70
X402	CROSSPOLE	70
X404	CROSSPOLE	70
X406	CROSSPOLE	70
X406TUBE	CROSSPOLE	70

bogen imaging

Bogen Imaging Inc.
565 East Crescent Avenue,
Ramsey, NJ 07446-0506
Tel (201) 818-9500
Service Only (201) 818-0060
Fax (201) 818-0060
www.bogenimaging.us
info@bogenimaging.com

© Gruppo Manfrotto 2008

Whilst every effort has been made to ensure that the information contained within this catalogue is correct, Gruppo Manfrotto srl accepts no liability for errors or omissions. Technical specifications and data are provided for guidance only. All rights are strictly reserved. Products shown in this catalogue are protected by international patents, while this publication (in whole or in part) without written consent from Gruppo Manfrotto srl is strictly forbidden and punishable by law. Because we constantly aim to improve our products, we reserve the right to amend or alter at any time and without prior notice the specifications of any item detailed in this publication.

ISSUE CODE LCATAVE08,L ISSUE NUMBER N°1 - LIT #75